

ASME B30.4-2015
(Revision of ASME B30.4-2010)

Portal and Pedestal Cranes

**Safety Standard for Cableways,
Cranes, Derricks, Hoists, Hooks, Jacks,
and Slings**

AN AMERICAN NATIONAL STANDARD



**The American Society of
Mechanical Engineers**

ASME B30.4-2015
(Revision of ASME B30.4-2010)

Portal and Pedestal Cranes

**Safety Standard for Cableways,
Cranes, Derricks, Hoists, Hooks, Jacks,
and Slings**

AN AMERICAN NATIONAL STANDARD



**The American Society of
Mechanical Engineers**

Two Park Avenue • New York, NY • 10016 USA

Date of Issuance: June 30, 2015

The next edition of this Standard is scheduled for publication in 2020. This Standard will become effective 1 year after the Date of Issuance.

ASME issues written replies to inquiries concerning interpretations of technical aspects of this Standard. Interpretations are published on the ASME Web site under the Committee Pages at <http://cstools.asme.org/> as they are issued.

Errata to codes and standards may be posted on the ASME Web site under the Committee Pages to provide corrections to incorrectly published items, or to correct typographical or grammatical errors in codes and standards. Such errata shall be used on the date posted.

The Committee Pages can be found at <http://cstools.asme.org/>. There is an option available to automatically receive an e-mail notification when errata are posted to a particular code or standard. This option can be found on the appropriate Committee Page after selecting “Errata” in the “Publication Information” section.

ASME is the registered trademark of The American Society of Mechanical Engineers.

This code or standard was developed under procedures accredited as meeting the criteria for American National Standards. The Standards Committee that approved the code or standard was balanced to assure that individuals from competent and concerned interests have had an opportunity to participate. The proposed code or standard was made available for public review and comment that provides an opportunity for additional public input from industry, academia, regulatory agencies, and the public-at-large.

ASME does not “approve,” “rate,” or “endorse” any item, construction, proprietary device, or activity.

ASME does not take any position with respect to the validity of any patent rights asserted in connection with any items mentioned in this document, and does not undertake to insure anyone utilizing a standard against liability for infringement of any applicable letters patent, nor assumes any such liability. Users of a code or standard are expressly advised that determination of the validity of any such patent rights, and the risk of infringement of such rights, is entirely their own responsibility.

Participation by federal agency representative(s) or person(s) affiliated with industry is not to be interpreted as government or industry endorsement of this code or standard.

ASME accepts responsibility for only those interpretations of this document issued in accordance with the established ASME procedures and policies, which precludes the issuance of interpretations by individuals.

No part of this document may be reproduced in any form,
in an electronic retrieval system or otherwise,
without the prior written permission of the publisher.

The American Society of Mechanical Engineers
Two Park Avenue, New York, NY 10016-5990

Copyright © 2015 by
THE AMERICAN SOCIETY OF MECHANICAL ENGINEERS
All rights reserved
Printed in U.S.A.

CONTENTS

Foreword	v
Committee Roster	vii
Introduction	ix
Summary of Changes	xii
Chapter 4-0	1
Scope, Definitions, Personnel Competence, and References	1
Section 4-0.1 Scope of B30.4	1
Section 4-0.2 Definitions	1
Section 4-0.3 Personnel Competence	5
Section 4-0.4 References	5
Chapter 4-1	6
Erection, Characteristics, and Construction	6
Section 4-1.1 Site Preparation and Erection	6
Section 4-1.2 Load Ratings and Stability	7
Section 4-1.3 Documentation	8
Section 4-1.4 Hoisting Equipment	9
Section 4-1.5 Luffing (Boom Hoist) and Trolley Equipment	10
Section 4-1.6 Slewing (Swing) Mechanism	11
Section 4-1.7 Travel Equipment	11
Section 4-1.8 Brakes, General Requirements	11
Section 4-1.9 Lifting Magnets	11
Section 4-1.10 Operational Aids	11
Section 4-1.11 Boom and Jib Support Ropes	12
Section 4-1.12 Reeving Accessories	12
Section 4-1.13 Counterweights	12
Section 4-1.14 Controls	12
Section 4-1.15 Translations of Safety-Related Information and Control Designations	14
Section 4-1.16 Electrical Equipment	14
Section 4-1.17 Operator’s Cabs	14
Section 4-1.18 General Requirements	15
Chapter 4-2	16
Inspection, Testing, and Maintenance	16
Section 4-2.1 Inspection	16
Section 4-2.2 Operational Aids	17
Section 4-2.3 Testing	17
Section 4-2.4 Maintenance	17
Section 4-2.5 Rope Inspection, Replacement, and Maintenance	18
Chapter 4-3	21
Operation	21
Section 4-3.1 Qualifications and Responsibilities	21
Section 4-3.2 Operating Practices	24
Section 4-3.3 Signals	26
Section 4-3.4 Miscellaneous	26
Figures	
4-0.2.1-1 Pedestal Crane With Luffing Boom	2
4-0.2.1-2 Portal Crane With Level Luffing Boom	2
4-0.2.1-3 Portal Crane With Luffing Boom	3
4-1.12-1 Wedge Sockets	13

4-2.5.2-1	Core Failure in 19 × 7 Rotation-Resistant Rope	19
4-3.3.4-1	Standard Hand Signals for Controlling Portal and Pedestal Cranes	27
4-3.4.2-1	Danger Zone for Cranes and Lifted Loads Operating Near Electrical Transmission Lines	29
Table		
4-3.4.2-1	Required Clearance for Normal Voltage in Operation Near High Voltage Power Lines	30

FOREWORD

This American National Standard, Safety Standard for Cableways, Cranes, Derricks, Hoists, Hooks, Jacks, and Slings, has been developed under the procedures accredited by the American National Standards Institute (ANSI). This Standard had its beginning in December 1916 when an eight-page Code of Safety Standards for Cranes, prepared by an ASME Committee on the Protection of Industrial Workers, was presented at the annual meeting of the ASME.

Meetings and discussions regarding safety on cranes, derricks, and hoists were held from 1920 to 1925, involving the ASME Safety Code Correlating Committee, the Association of Iron and Steel Electrical Engineers, the American Museum of Safety, the American Engineering Standards Committee (AESC) [later changed to American Standards Association (ASA), then to the United States of America Standards Institute (USASI), and finally to ANSI], Department of Labor — State of New Jersey, Department of Labor and Industry — State of Pennsylvania, and the Locomotive Crane Manufacturers Association. On June 11, 1925, AESC approved the ASME Safety Code Correlating Committee's recommendation and authorized the project with the U.S. Department of the Navy, Bureau of Yards and Docks, and ASME as sponsors.

In March 1926, invitations were issued to 50 organizations to appoint representatives to a Sectional Committee. The call for organization of this Sectional Committee was sent out October 2, 1926, and the committee organized November 4, 1926, with 57 members representing 29 national organizations. Commencing June 1, 1927, and using the eight-page code published by ASME in 1916 as a basis, the Sectional Committee developed the Safety Code for Cranes, Derricks, and Hoists. The early drafts of this safety code included requirements for jacks, but, due to inputs and comments on those drafts, the Sectional Committee decided in 1938 to make the requirements for jacks a separate code. In January 1943, ASA B30.2-1943 was published addressing a multitude of equipment types, and in August 1943, ASA B30.1-1943 was published just addressing jacks. Both documents were reaffirmed in 1952 and widely accepted as safety standards.

Due to changes in design, advancement in techniques, and general interest of labor and industry in safety, the Sectional Committee, under the joint sponsorship of ASME and the Bureau of Yards and Docks (now the Naval Facilities Engineering Command), was reorganized on January 31, 1962, with 39 members representing 27 national organizations. The new committee changed the format of ASA B30.2-1943 so that the multitude of equipment types it addressed could be published in separate volumes that could completely cover the construction, installation, inspection, testing, maintenance, and operation of each type of equipment that was included in the scope of ASA B30.2. This format change resulted in the initial publication of B30.3, B30.5, B30.6, B30.11, and B30.16 being designated as revisions of B30.2, with the remainder of the B30 volumes being published as totally new volumes. ASA changed its name to USASI in 1966 and to ANSI in 1969, which resulted in B30 volumes from 1943 to 1968 being designated as either ASA B30, USAS B30, or ANSI B30, depending on their date of publication.

In 1982, the Committee was reorganized as an Accredited Organization Committee, operating under procedures developed by ASME and accredited by ANSI. This Standard presents a coordinated set of rules that may serve as a guide to government and other regulatory bodies and municipal authorities responsible for the guarding and inspection of the equipment falling within its scope. The suggestions leading to accident prevention are given both as mandatory and advisory provisions; compliance with both types may be required by employers of their employees.

In case of practical difficulties, new developments, or unnecessary hardship, the administrative or regulatory authority may grant variances from the literal requirements or permit the use of other devices or methods but only when it is clearly evident that an equivalent degree of protection is thereby secured. To secure uniform application and interpretation of this Standard, administrative or regulatory authorities are urged to consult the B30 Committee, in accordance with the format described in Section IX of the Introduction, before rendering decisions on disputed points.

Safety codes and standards are intended to enhance public safety. Revisions result from committee consideration of factors such as technological advances, new data, and changing environmental and industry needs. Revisions do not imply that previous editions were inadequate.

B30.4 has been in existence since 1943. New editions were published in 1973 and 1981 under the title Portal, Tower, and Pillar Cranes. The 1990, 1996, and 2003 Editions were published under the title Portal, Tower, and Pedestal Cranes. For the 2010 Edition, B30.4 removed all references to tower cranes and revised the title to Portal and Pedestal Cranes. All requirements for tower cranes were incorporated into B30.3-2009. This 2015 Edition contains technical and editorial revisions, including the addition of responsibilities of personnel, personnel competence, and translations.

This Volume of the Standard, which was approved by the B30 Committee and by ASME, was approved by ANSI and designated as an American National Standard on May 19, 2015.

ASME B30 COMMITTEE

Safety Standard for Cableways, Cranes, Derricks, Hoists, Hooks, Jacks, and Slings

(The following is the roster of the Committee at the time of approval of this Standard.)

STANDARDS COMMITTEE OFFICERS

B. D. Closson, *Chair*
T. L. Blanton, *Vice Chair*
K. M. Hyam, *Secretary*

STANDARDS COMMITTEE PERSONNEL

N. E. Andrew, LTS Cranes Mechanical
M. Eggenberger, *Alternate*, Berry Contracting, Inc.
G. Austin, Terex Corp.
T. L. Blanton, NACB Group, Inc.
R. Ohman, *Alternate*, Verde Concepts, Inc.
P. A. Boeckman, The Crosby Group
C. E. Lucas, *Alternate*, The Crosby Group
P. W. Boyd, The Boeing Co.
M. E. Brunet, The Manitowoc Co.
A. L. Calta, *Alternate*, The Manitowoc Co.
B. D. Closson, Craft Forensic Service
B. A. Pickett, *Alternate*, Systems Engineering and Forensic Services
J. A. Danielson, The Boeing Co.
D. Decker, Becket LLC
L. D. DeMark, Equipment Training Solutions LLC
D. F. Jordan, *Alternate*, BP America
D. W. Eckstine, Eckstine & Associates
G. J. Brent, *Alternate*, NCCCO
R. J. Edwards, NBIS Claims and Risk Management, Inc.
A. J. Egging, National Oilwell Varco
R. Stanoch, *Alternate*, National Oilwell Varco
E. D. Fidler, The Manitowoc Co.
G. D. Miller, *Alternate*, The Manitowoc Co.
J. A. Gilbert, Associated Wire Rope Fabricators
J. L. Gordon, Associated Chain and Lifting Products
N. C. Hargreaves, Hargreaves Consulting LLC
G. B. Hetherston, E. I. DuPont
R. J. Bolen, *Alternate*, E. I. DuPont
K. M. Hyam, The American Society of Mechanical Engineers
M. M. Jaxtheimer, Navy Crane Center
S. R. Gridley, *Alternate*, Navy Crane Center
P. R. Juhren, Morrow Equipment Co. LLC
M. J. Quinn, *Alternate*, Morrow Equipment Co. LLC
R. M. Kohner, Landmark Engineering Services, Ltd.
D. Duerr, *Alternate*, 2DM Associates, Inc.
A. J. Lusi, Jr., Lumark Consulting LLP
K. J. Shinn, *Alternate*, K. J. Shinn, Inc.
E. K. Marburg, Columbus McKinnon Corp.
J. R. Burkey, *Alternate*, Columbus McKinnon Corp.
L. D. Means, Means Engineering and Consulting
D. A. Henninger, *Alternate*, Bridon American
M. W. Mills, Liberty Mutual Insurance
D. M. Gordon, *Alternate*, Liberty Mutual Insurance
D. L. Morgan, Critical Lift Consultants LLC
T. C. Mackey, *Alternate*, WRPS Hanford
W. E. Osborn, Ingersoll Rand
S. D. Wood, *Alternate*, Link-Belt Construction Equipment Co.
R. M. Parnell, Industrial Training International
W. C. Dickinson, Jr., *Alternate*, Industrial Training International
J. T. Perkins, Solarex
J. R. Schober, *Alternate*, American Bridge Co.
J. E. Richardson, Navy Crane Center
K. Kennedy, *Alternate*, Navy Crane Center
D. W. Ritchie, David Ritchie Consultant LLC
L. K. Shapiro, *Alternate*, Howard I. Shapiro & Associates
J. W. Rowland III, Consultant
D. A. Moore, *Alternate*, Unified Engineering
J. C. Ryan, Boh Bros. Construction Co.
A. R. Ruud, *Alternate*, Atkinson Construction
D. W. Smith, STI Group
S. K. Rammelsberg, *Alternate*, Chicago Bridge & Iron Co.
W. J. Smith, Jr., NBIS Claims and Risk Management, Inc.
J. Schoppert, *Alternate*, NBIS Claims and Risk Management, Inc.
R. S. Stemp, Lampson International LLC
E. P. Vliet, *Alternate*, Turner Industries Group
R. G. Strain, Advanced Crane Technologies LLC
J. Sturm, Sturm Corp.
P. D. Sweeney, General Dynamics Electric Boat
B. M. Casey, *Alternate*, General Dynamics Electric Boat
J. D. Wiethorn, Haag Engineering Co.
M. Gardiner, *Alternate*, Haag Engineering Co.
R. C. Wild, CJ Drilling, Inc.
J. Dudley, *Alternate*, Archer Western Contractors
D. N. Wolff, National Crane/Manitowoc Crane Group
J. A. Pilgrim, *Alternate*, Manitowoc Crane Group

HONORARY MEMBERS

J. W. Downs, Jr., Downs Crane and Hoist Co.
J. L. Franks, Consultant
C. W. Ireland, National Oilwell Varco
J. M. Klibert, Lift-All Co., Inc.
R. W. Parry, Consultant
P. S. Zorich, Consultant

B30.4 SUBCOMMITTEE PERSONNEL

A. J. Egging, *Chair*, National Oilwell Varco
J. D. Cannon, Consultant
J. P. Colletti, John P. Colletti & Associates, Inc.
C. W. Ireland, National Oilwell Varco

M. M. Jaxtheimer, Navy Crane Center
J. E. Richardson, Navy Crane Center
R. Stanoch, National Oilwell Varco
P. S. Zorich, Consultant

B30 INTEREST REVIEW GROUP

O. Akinboboye, Ropetech Engineering Services
J. D. Cannon, Consultant
M. Eggenberger, Berry Contracting, Inc.
A. Gomes Rocha, Belgo Bekaert Arames
H. A. Hashem, Saudi Aramco
J. Hui, Sipailou 2#, School of Civil Engineering

C. Lan, DOI-BSEE
A. C. Mattoli, Prowinch LLC
M. W. Osborne, E-Crane International USA
G. L. Owens, Consultant
W. Rumburg, Crane Consultants, Inc.
C.-C. Tsaor, Institute of Occupational Safety on Health

B30 REGULATORY AUTHORITY COUNCIL

C. Shelhamer, *Chair*, New York City Department of Buildings
A. O. Omran, *Alternate*, New York City Department of Buildings
K. M. Hyam, *Secretary*, American Society of Mechanical Engineers
L. G. Champion, DOL/OSHA
W. L. Cooper, ADOSH
R. Feidt, Stephenson Equipment, Inc.
C. Harris, City of Chicago — Department of Buildings

J. L. Lankford, State of Nevada (OSHA)
A. Lundeen, State of Washington, Department of Labor and Industries
G. E. Pushies, MIOSHA
C. N. Stribling, Jr., Kentucky Labor Cabinet
T. Taylor, State of Minnesota, Department of Labor and Industry
C. Tolson, State of California, OSH Standards Board

SAFETY STANDARD FOR CABLEWAYS, CRANES, DERRICKS, HOISTS, HOOKS, JACKS, AND SLINGS

B30 STANDARD INTRODUCTION

(15)

SECTION I: SCOPE

The ASME B30 Standard contains provisions that apply to the construction, installation, operation, inspection, testing, maintenance, and use of cranes and other lifting and material-movement related equipment. For the convenience of the reader, the Standard has been divided into separate volumes. Each volume has been written under the direction of the ASME B30 Standard Committee and has successfully completed a consensus approval process under the general auspices of the American National Standards Institute (ANSI).

As of the date of issuance of this Volume, the B30 Standard comprises the following volumes:

- B30.1 Jacks, Industrial Rollers, Air Casters, and Hydraulic Gantries
- B30.2 Overhead and Gantry Cranes (Top Running Bridge, Single or Multiple Girder, Top Running Trolley Hoist)
- B30.3 Tower Cranes
- B30.4 Portal and Pedestal Cranes
- B30.5 Mobile and Locomotive Cranes
- B30.6 Derricks
- B30.7 Winches
- B30.8 Floating Cranes and Floating Derricks
- B30.9 Slings
- B30.10 Hooks
- B30.11 Monorails and Underhung Cranes
- B30.12 Handling Loads Suspended From Rotorcraft
- B30.13 Storage/Retrieval (S/R) Machines and Associated Equipment
- B30.14 Side Boom Tractors
- B30.15 Mobile Hydraulic Cranes
(withdrawn 1982 — requirements found in latest revision of B30.5)
- B30.16 Overhead Hoists (Underhung)
- B30.17 Overhead and Gantry Cranes (Top Running Bridge, Single Girder, Underhung Hoist)
- B30.18 Stacker Cranes (Top or Under Running Bridge, Multiple Girder With Top or Under Running Trolley Hoist)
- B30.19 Cableways
- B30.20 Below-the-Hook Lifting Devices
- B30.21 Lever Hoists
- B30.22 Articulating Boom Cranes
- B30.23 Personnel Lifting Systems
- B30.24 Container Cranes
- B30.25 Scrap and Material Handlers
- B30.26 Rigging Hardware
- B30.27 Material Placement Systems
- B30.28 Balance Lifting Units
- B30.29 Self-Erecting Tower Cranes
- B30.30 Ropes¹

SECTION II: SCOPE EXCLUSIONS

Any exclusion of, or limitations applicable to the equipment, requirements, recommendations, or operations contained in this Standard are established in the affected volume's scope.

SECTION III: PURPOSE

The B30 Standard is intended to

- (a) prevent or minimize injury to workers, and otherwise provide for the protection of life, limb, and property by prescribing safety requirements
- (b) provide direction to manufacturers, owners, employers, users, and others concerned with, or responsible for, its application
- (c) guide governments and other regulatory bodies in the development, promulgation, and enforcement of appropriate safety directives

SECTION IV: USE BY REGULATORY AGENCIES

These volumes may be adopted in whole or in part for governmental or regulatory use. If adopted for governmental use, the references to other national codes and standards in the specific volumes may be changed to refer to the corresponding regulations of the governmental authorities.

SECTION V: EFFECTIVE DATE

(a) *Effective Date.* The effective date of this Volume of the B30 Standard shall be 1 yr after its date of issuance.

¹ This volume is currently in the development process.

Construction, installation, inspection, testing, maintenance, and operation of equipment manufactured and facilities constructed after the effective date of this Volume shall conform to the mandatory requirements of this Volume.

(b) *Existing Installations.* Equipment manufactured and facilities constructed prior to the effective date of this Volume of the B30 Standard shall be subject to the inspection, testing, maintenance, and operation requirements of this Standard after the effective date.

It is not the intent of this Volume of the B30 Standard to require retrofitting of existing equipment. However, when an item is being modified, its performance requirements shall be reviewed relative to the requirements within the current volume. The need to meet the current requirements shall be evaluated by a qualified person selected by the owner (user). Recommended changes shall be made by the owner (user) within 1 yr.

SECTION VI: REQUIREMENTS AND RECOMMENDATIONS

Requirements of this Standard are characterized by use of the word *shall*. Recommendations of this Standard are characterized by the word *should*.

SECTION VII: USE OF MEASUREMENT UNITS

This Standard contains SI (metric) units as well as U.S. Customary units. The values stated in U.S. Customary units are to be regarded as the standard. The SI units are a direct (soft) conversion from the U.S. Customary units.

SECTION VIII: REQUESTS FOR REVISION

The B30 Standard Committee will consider requests for revision of any of the volumes within the B30 Standard. Such requests should be directed to

Secretary, B30 Standard Committee
ASME Codes and Standards
Two Park Avenue
New York, NY 10016-5990

Requests should be in the following format:

- Volume: Cite the designation and title of the volume.
- Edition: Cite the applicable edition of the volume.
- Subject: Cite the applicable paragraph number(s) and the relevant heading(s).
- Request: Indicate the suggested revision.
- Rationale: State the rationale for the suggested revision.

Upon receipt by the Secretary, the request will be forwarded to the relevant B30 Subcommittee for consideration and action. Correspondence will be provided to

the requester defining the actions undertaken by the B30 Standard Committee.

SECTION IX: REQUESTS FOR INTERPRETATION

The B30 Standard Committee will render an interpretation of the provisions of the B30 Standard. Such requests should be directed to

Secretary, B30 Standard Committee
ASME Codes and Standards
Two Park Avenue
New York, NY 10016-5990

Requests should be in the following format:

- Volume: Cite the designation and title of the volume.
- Edition: Cite the applicable edition of the volume.
- Subject: Cite the applicable paragraph number(s) and the relevant heading(s).
- Question: Phrase the question as a request for an interpretation of a specific provision suitable for general understanding and use, not as a request for approval of a proprietary design or situation. Plans or drawings that explain the question may be submitted to clarify the question. However, they should not contain any proprietary names or information.

Upon receipt by the Secretary, the request will be forwarded to the relevant B30 Subcommittee for a draft response, which will then be subject to approval by the B30 Standard Committee prior to its formal issuance.

Interpretations to the B30 Standard will be published in the subsequent edition of the respective volume, and will be available online at <http://cstools.asme.org/>.

SECTION X: ADDITIONAL GUIDANCE

The equipment covered by the B30 Standard is subject to hazards that cannot be abated by mechanical means, but only by the exercise of intelligence, care, and common sense. It is therefore essential to have personnel involved in the use and operation of equipment who are competent, careful, physically and mentally qualified, and trained in the proper operation of the equipment and the handling of loads. Serious hazards include, but are not limited to, improper or inadequate maintenance, overloading, dropping or slipping of the load, obstructing the free passage of the load, and using equipment for a purpose for which it was not intended or designed.

The B30 Standard Committee fully realizes the importance of proper design factors, minimum or maximum dimensions, and other limiting criteria of wire rope or chain and their fastenings, sheaves, sprockets, drums, and similar equipment covered by the standard, all of

which are closely connected with safety. Sizes, strengths, and similar criteria are dependent on many different factors, often varying with the installation and uses. These factors depend on

- (a) the condition of the equipment or material
- (b) the loads
- (c) the acceleration or speed of the ropes, chains, sheaves, sprockets, or drums
- (d) the type of attachments

(e) the number, size, and arrangement of sheaves or other parts

(f) environmental conditions causing corrosion or wear

(g) many variables that must be considered in each individual case

The requirements and recommendations provided in the volumes must be interpreted accordingly, and judgment used in determining their application.

ASME B30.4-2015 SUMMARY OF CHANGES

Following approval by the ASME B30 Committee and ASME, and after public review, ASME B30.4-2015 was approved by the American National Standards Institute on May 19, 2015.

ASME B30.4-2015 includes editorial changes, revisions, and corrections introduced in ASME B30.4-2010, as well as the following changes identified by (15).

<i>Page</i>	<i>Location</i>	<i>Change</i>
ix–xi	B30 Standard Introduction	Updated
1	Chapter 4-0	Title revised
	Section 4-0.1	Revised
	4-0.2.2	(1) Terms <i>appointed, authorized, designated person, and wind velocity device</i> deleted (2) Terms <i>alteration, maximum operating wind speed, minimum breaking force, and operational aid</i> added
5	Section 4-0.3	Added
	Section 4-0.4	Updated
7	4-1.2.1	Subparagraph (d) revised
	4-1.2.2	Subparagraphs (b) through (d) revised
8	4-1.2.3	Former subpara. (b) deleted, and remaining subparagraphs redesignated
	4-1.2.4	Subparagraph (b)(5) added
	4-1.2.5	Revised in its entirety
	4-1.2.6	Revised
9	4-1.4.2	(1) Subparagraphs (c) and (e) revised (2) Subparagraph (f) deleted
10	4-1.4.5	Subparagraphs (c) and (g) revised
	4-1.5.2	Subparagraph (a) revised
11, 12	4-1.7.1	Subparagraph (d) added
	4-1.7.3	Subparagraph (c) deleted
	Section 4-1.9	Revised in its entirety
	Section 4-1.10	Added, and remaining paragraphs redesignated
	Section 4-1.11	Subparagraph (c) revised
	4-1.14.1	Subparagraph (a) revised
13	Fig. 4-1.12-1	Added, and Fig. 4-1.11.4-1 deleted
14	Section 4-1.15	Added, and remaining paragraphs redesignated

<i>Page</i>	<i>Location</i>	<i>Change</i>
	4-1.17.1	Subparagraph (e) revised
	4-1.17.2	Subparagraph (a) revised
16, 17	4-2.1.1	Revised
	4-2.1.2	Subparagraphs (a), (b)(1), and (b)(2) revised
	4-2.1.3	(1) First paragraph and subparas. (b), (e), and (i) revised (2) Subparagraph (k) added
	4-2.1.4	Subparagraphs (c) through (e) revised
	Section 4-2.2	Added, and remaining paragraphs redesignated
	Section 4-2.3	Revised in its entirety
	4-2.4.1	Subparagraph (a) revised
18–20	4-2.4.5	Subparagraph (b) revised
	Section 4-2.5	Paragraphs 4-2.5.1 through 4-2.5.3 revised
21	Section 4-3.1	Title revised
	4-3.1.1	Subparagraphs (a)(2) and (b) revised
22–26	4-3.1.3	Revised in its entirety
	4-3.2.1	Revised in its entirety
	4-3.2.2	Revised in its entirety
	4-3.3.1	Added, and remaining paragraphs redesignated
	4-3.3.2	Revised
	4-3.3.3	Added, and remaining paragraphs redesignated
	4-3.3.4	Title revised
	4-3.3.5	Added, and remaining paragraphs redesignated
	4-3.3.6	Revised
	4-3.3.7	Added
	4-3.3.8	Added

INTENTIONALLY LEFT BLANK

PORTAL AND PEDESTAL CRANES

Chapter 4-0

(15)

Scope, Definitions, Personnel Competence, and References

(15) SECTION 4-0.1: SCOPE OF B30.4

Volume B30.4 includes provisions that apply to the construction, installation, operation, inspection, testing, and maintenance of electric motor or internal-combustion engine-powered portal and pedestal cranes that adjust operating radius by means of a boom luffing mechanism or by means of a trolley traversing a horizontal boom, that may be mounted on a fixed or traveling base, and to any variation thereof that retain the same fundamental characteristics.

This Volume applies only to portal and pedestal cranes utilizing a drum and wire rope for hoisting and that are used for hoisting work. The requirements for tower cranes (refer to ASME B30.3), telescopic boom cranes, twin boom container handling cranes, and articulating boom cranes are not included in this Volume.

SECTION 4-0.2: DEFINITIONS

4-0.2.1 Types of Cranes

luffing crane: a crane with a boom pinned to the superstructure at its inner end and containing load-hoisting tackle at its outer end and with a hoist mechanism to raise or lower the boom in a vertical plane to change load radius (see Figs. 4-0.2.1-1 through 4-0.2.1-3).

pedestal crane: a crane consisting of a rotating superstructure with operating machinery and boom, all of which is mounted on a pedestal (see Fig. 4-0.2.1-1).

portal crane: a crane consisting of a rotating superstructure with operating machinery and boom, all of which is mounted on a gantry structure, usually with a portal opening between the gantry columns or legs for traffic to pass beneath the crane. The crane may be fixed or on a traveling base (see Figs. 4-0.2.1-2 and 4-0.2.1-3).

(15) 4-0.2.2 General

accessory: a secondary part or assembly of parts that contributes to the overall function and usefulness of a machine.

administrative or regulatory authority: governmental agency or the employer in the absence of governmental jurisdiction.

alteration (modification): any change in the original equipment manufacturer's design configuration of the crane that pertains to load-supporting components, load-positioning components, and other components that affect the safe load-carrying capability of the crane (e.g., counterweights, holding valves), including operational aids, limit devices, and other safety equipment.

axis of rotation: the vertical axis around which the crane superstructure rotates.

bogie: an assembly of two or more axles arranged to permit both vertical wheel displacement and an equalization of loading on the wheels.

boom: a member used for supporting the hoisting tackle, hinged to a fixed or rotating structure or to a mast, with its outer end supported by ropes, chains, rods, or hydraulic cylinder(s).

boom point: the outward end of the load-bearing boom.

boom stop: a device or structure designed to limit boom travel to its highest allowable position.

brake: a device, other than a motor, used for retarding or stopping motion by friction or power means.

braking means: a method or device for retarding or stopping motion.

buffer/bumper: an energy-absorbing device for reducing impact when a moving boom or crane reaches the end of its permitted travel.

cab: a housing provided for the operator and containing the crane controls.

clutch: a means for engagement or disengagement of power.

counterweight: weight used to supplement the weight of the machine in providing stability for lifting working loads; it swings with the crane.

crane, standby: crane that is not in regular service but used occasionally or intermittently as required.

drum: the cylindrical member around which a rope is wound and through which power is transmitted to the ropes.

Fig. 4-0.2.1-1 Pedestal Crane With Luffing Boom

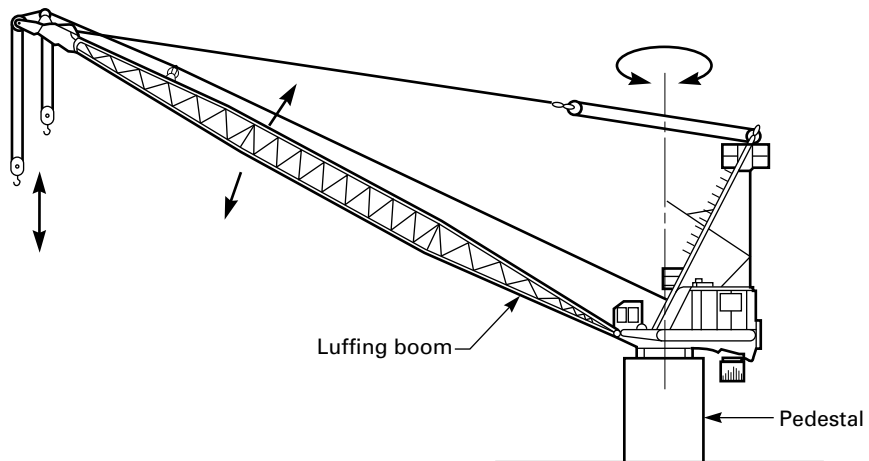

Fig. 4-0.2.1-2 Portal Crane With Level Luffing Boom

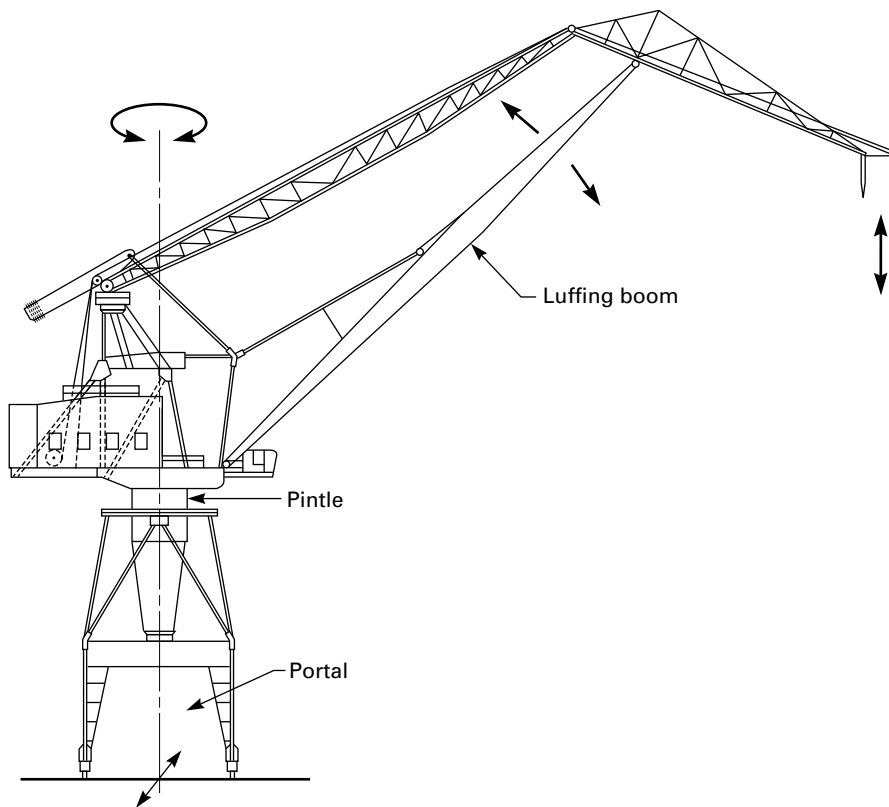
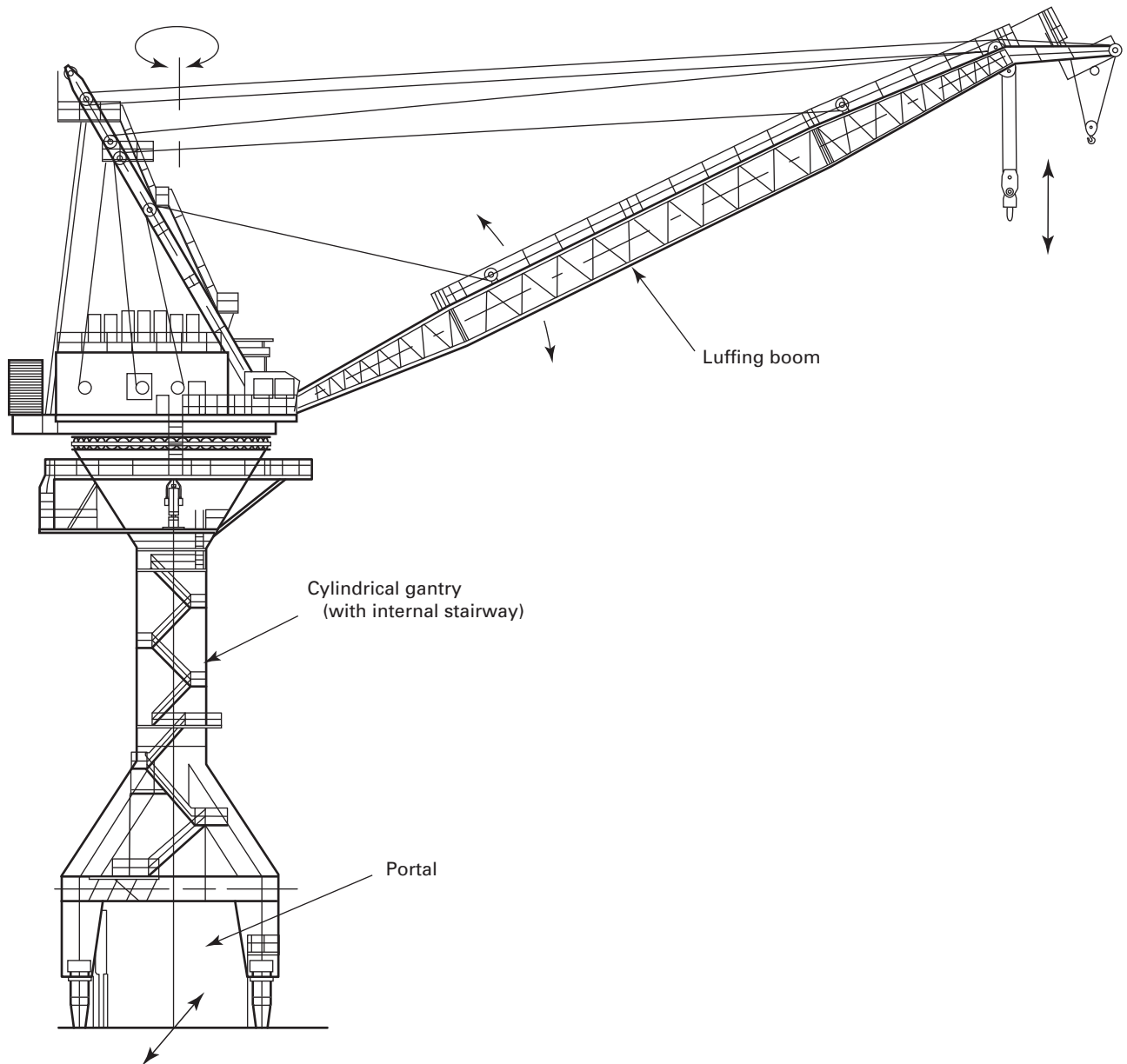

Fig. 4-0.2.1-3 Portal Crane With Luffing Boom



dynamic loading: loads introduced into the machine or its components by forces in motion.

flange point: the point of contact between the rope and drum flange where the rope changes layers on a rope drum.

gage, track: the horizontal distance between the center lines of the tow rails measured perpendicular to the direction of travel.

gantry: a movable structural frame consisting of columns and bracing capable of supporting a crane with its working and dynamic loads.

high-strength (traction) bolts: high-strength tensile bolts used in the assembly of crane components. The bolts are installed in tension, by torquing or other means, at a level greater than that produced by in- or out-of-service loads for the purpose of reducing the likelihood of bolt fatigue failure.

in-service: the condition of a crane ready for or engaged in work; an operator is at the controls.

jib: an extension attached to the boom point to provide added boom length for lifting specified loads. The jib may be in line with the boom or offset to various angles.

load, working: the external load applied to the crane, including the weight of load-attaching equipment, such as load blocks, ropes, shackles, and slings.

load block, lower: the assembly of sheaves, pins, and frame suspended from the boom or mounted in the load trolley.

load hoist: a hoist drum and rope reeving system used for hoisting and lowering loads.

maximum operating wind speed: the maximum wind speed permitted by the crane manufacturer for the continued operation of the crane.

minimum breaking force: the minimum load at which a new and unused wire rope will break when loaded to destruction in direct tension.

operational aid: an accessory that provides information to facilitate operation of a crane or that takes control of particular functions without action of the operator when a limiting condition is sensed. Examples of such devices include, but are not limited to, the following: anti-two block device, rated capacity indicator, rated capacity (load) limiter, boom angle or radius indicator, drum rotation indicator, load indicator, and wind speed indicator.

out-of-service: the condition of a crane when unloaded, without power and with the controls unattended, and prepared to endure winds above the in-service level.

parking track: for rail-mounted cranes, a section of track supported so that it is capable of sustaining storm-induced bogie loads; it is provided with storm anchorages when required.

pawl (dog): a device for positively holding a member against motion in one or more directions.

pedestal: a fixed raised crane base or foundation that may be solid, enclosed, or framed but without a portal opening.

permanent installation: a crane installation intended to last the working life of the crane or for a period of 5 yr or more before dismantling and re-erection.

pitch diameter: the diameter of a sheave or rope drum measured at the centerline of the rope.

qualified person: a person who, by possession of a recognized degree in an applicable field or certificate of professional standing, or who, by extensive knowledge, training, and experience, has successfully demonstrated the ability to solve or resolve problems relating to the subject matter and work.

radius (load): the horizontal distance from a projection of the axis of rotation to the base of the crane tower, gantry, or pedestal, before loading, to the center of vertical hoist line or tackle with load applied.

rail clamp: a device for fastening a traveling crane to its rails to limit wind-induced travel.

remote-control station: a location, not on the crane, from which the operator can control all the crane movements.

rope: refers to wire rope unless otherwise specified.

rotation-resistant rope: wire rope consisting of an inner layer of strand laid in one direction covered by a layer of strand laid in the opposite direction. This has the effect of counteracting torque by reducing the tendency of the finished rope to rotate.

service, heavy: that service that involves operating at 85% to 100% of rated load or in excess of ten lift cycles per hour as a regular specified procedure.

service, light: service that involves irregular operation with loads generally about one-half or less of the rated load.

service, normal: that service that involves operating at less than 85% rated load and not more than ten lift cycles per hour except for isolated instances.

service life: the time, expressed as the sum of the periods of operation, over which a stressed component can function without undue risk of failure when the crane is operated in accordance with the manufacturer's instructions under either light, normal, or heavy service.

shall: indicates that the rule is mandatory and must be followed.

should: indicates that the rule is a recommendation, the advisability of which depends on facts in each situation.

standing rope (pendant): a supporting rope that maintains a constant distance between the points of attachment to the components connected by the rope.

structural competence: the ability of the machine and its components to withstand the stresses imposed by applied rated loads.

swing (slew): rotation of the superstructure for movement of loads in a horizontal direction about the axis of rotation.

switch, limit: a device that is actuated by the motion of a part of a power-driven machine or equipment to alter or disconnect the electric, hydraulic, or pneumatic circuit associated with the machine or equipment.

ton (short): 2,000 lb.

tower: a structural frame consisting of columns and bracing capable of supporting a superstructure with its working and dynamic loads.

traction (high-strength) bolts: see *high-strength (traction) bolts*.

trolley, load: the device that travels along the horizontal boom of a hammerhead crane and contains the upper load block.

truck, travel: the assembly that includes a pivot, frame, axle(s), and wheel(s) on which a crane rides on rails (see also *bogie*).

two-blocking: the condition when the lower load block or hook assembly comes in contact with the upper load block.

unattended: a condition in which the operator of a crane is not at the operating controls.

weathervaning: wind-induced swinging of a crane, when out of service, so as to expose minimal surface area to the wind.

(15) SECTION 4-0.3: PERSONNEL COMPETENCE

Persons performing the functions identified in this Volume shall meet the applicable qualifying criteria stated in this Volume and shall, through education, training, experience, skill, and physical ability, as necessary, be competent and capable to perform the functions as determined by the employer or employer's representative.

(15) SECTION 4-0.4: REFERENCES

Within the text, reference is made to the following publications, copies of which may be obtained from the publishers as indicated.

ANSI/ALI A14.3-2008, Safety Requirements for Ladders — Fixed

Publisher: American Ladder Institute (ALI), 330 North Wabash Avenue, Chicago, IL 60611 (www.americanladderinstitute.org)

ANSI/ASSE A1264.1-2007, Safety Requirements for Workplace Floor and Wall Openings, Stairs, and Railing Systems

Publisher: The American Society of Safety Engineers (ASSE), 1800 East Oakton Street, Des Plaines, IL 60018 (www.asse.org)

ANSI/AWS D14.3-2005, Specification for Welding Earth-Moving and Construction Equipment

Publisher: American Welding Society (AWS), 8669 NW 36 Street, No. 130, Miami, FL 33166 (www.aws.org)

ANSI/NEMA ICS3-2005 (R2010), Part ICS 3-443, Industrial Systems

Publisher: National Electrical Manufacturers Association (NEMA), 1300 North 17th Street, Rosslyn, VA 22209 (www.nema.org)

ANSI/NFPA 70-2011, National Electrical Code

Publisher: National Fire Protection Association (NFPA), 1 Batterymarch Park, Quincy, MA 02169 (www.nfpa.org)

ANSI/SAE J2703-2008, Cranes — Access and Egress
ANSI/SAE Z26.1-1996, Safety Code for Safety Glazing Materials for Glazing Motor Vehicles and Motor Vehicles Operating on Land Highways — Safety Standard

Publisher: SAE International, 400 Commonwealth Drive, Warrendale, PA 15096 (www.sae.org)

ASCE/SEI 7-10, Minimum Design Loads for Buildings and Other Structures

Publisher: American Society of Civil Engineers (ASCE), 1801 Alexander Bell Drive, Reston, VA 20191 (www.asce.org)

ASME B30.3-2012, Tower Cranes

ASME B30.10-2009, Hooks

ASME B30.23-2011, Personnel Lifting Systems

Publisher: The American Society of Mechanical Engineers (ASME), Two Park Avenue, New York, NY 10016-5990 (www.asme.org)

WRTB Wire Rope Users Manual, 4th Edition

Publisher: Wire Rope Technical Board (WRTB), 801 North Fairfax Street, Alexandria, VA 22314-1757 (www.domesticwirerope.org/wrtb/index.html)

Chapter 4-1

Erection, Characteristics, and Construction

SECTION 4-1.1: SITE PREPARATION AND ERECTION

4-1.1.1 Crane Supports

(a) All load-bearing foundations, supports, and rail tracks shall be constructed or installed to support the crane loads and transmit them to the soil or other support medium. In addition to supporting vertical load, foundations and supports, rail supports excepted, should be designed to provide a moment resisting overturning equal to a minimum of 150% of the maximum crane overturning moment.

(b) Rails should be level and straight, unless specifically designed for curves or grades, and properly spaced for the crane trucks in accordance with the manufacturer's specifications. The track and support system should have sufficient rigidity to limit dynamic oscillations and deviations from plumb.

(c) Rails shall be securely attached to the supporting surface in a manner capable of resisting the horizontal and vertical loads specified by the manufacturer. When applicable, provision should be made for thermal expansion and contraction.

(d) Splices in rail tracks (bolted or welded) shall have smooth joints.

(e) When required, a designated portion of the track should be arranged and constructed as an out-of-service parking area complete with means needed for supporting the crane against storm wind effects and anchoring it against unwanted movement along the track; the parking track should be in place before erection commences.

(f) Rails shall be electrically grounded when they carry cranes electrically powered from an outside source.

(g) Both ends of all tracks shall be provided with stops or buffers adjusted for simultaneous contact with both sides of the travel base.

(h) When more than one crane will be operating on a run of track, particular consideration should be given to the number and disposition of parking areas.

(i) The hazard of earthquake effects appropriate to the site or zone should be considered.

(j) The crane manufacturer or qualified person shall provide maximum resulting loads at the base of the crane, or wheel loads, for use in design of the supports (see para. 4-1.3.1).

4-1.1.2 General Erection Requirements

(a) When cranes are erected, the manufacturer's or a qualified person's written erection instructions and a

list of the weights of each component to be erected shall be at the site.

(b) Cranes shall be erected in accordance with the crane manufacturer's or a qualified person's recommendations. Erection shall be performed under the supervision of a qualified person.

(c) Procedures shall be established before erection work commences to implement the erection instructions and adapt them to the particular needs of the site. The need for temporary guying and bracing during erection shall be established.

(d) Before crane components are erected, they shall be visually inspected for damage. Damaged members shall not be erected until repaired in accordance with the manufacturer's or qualified person's instructions or replaced.

(e) Slings and lifting accessories should be selected and arranged to avoid damaging or marring crane members during erection.

(f) Wind velocity at the site at the time of erection should be considered as a limiting factor that could require suspending the erection operation.

(g) Crane towers should be erected plumb to a tolerance that is specified by the manufacturer.

(h) Cranes required to weathervane when out of service shall be installed with clearance for the boom and superstructure to swing through a full 360-deg arc without striking any fixed object or other crane.

4-1.1.3 Preoperation Procedures

(a) After erection, supports shall be tested, before placing the crane in service, using test loads that are 110% of rated load at the radius producing the greatest load moment. Pedestal cranes shall be tested with the load rotated slowly to those positions that cause maximum loading of each foundation and then held for at least 15 min at each critical position. Traveling cranes designed to travel with load shall be tested by slowly traveling the loaded crane the length of the runway with the crane oriented so as to cause maximum wheel loadings on one rail, then returning with the crane oriented to similarly load the other rail. If not designed to travel with load, traveling cranes shall also be tested as for a stationary crane in each operating location.

(b) During overload tests, care is required to maintain accelerations and decelerations below ordinary operational levels.

(c) Displacement of a support during testing is reason to refrain from placing the crane in operation until an evaluation is made by a qualified person.

(d) Before placing a crane in service, all functional motions, locking devices, and brakes shall be checked for operation. Limiting devices shall be checked for proper setting and operation.

(e) Functional motion tests shall be performed first without load and then at rated load, or where appropriate, with the overload test load boomed-in to rated radius. The tests shall include

- (1) load hoisting and lowering
- (2) boom hoisting and lowering or traversing the trolley
- (3) swing motion
- (4) brakes and clutches
- (5) limit, locking, and safety devices

(f) The trip setting of hoist limit devices should be determined by tests, with an empty hook comprising a series of runs each at increasing hook speed up to the maximum speed. The actuating mechanism of the limit device shall be located so that it will trip the device, under all conditions, in sufficient time to prevent contact of the lower load block with the upper load block or boom point sheaves.

(g) The order in which tests of a newly erected crane are to be performed is as follows:

- (1) functional motion test without load
- (2) functional motion tests at rated load
- (3) overload tests of supports

SECTION 4-1.2: LOAD RATINGS AND STABILITY

(15) 4-1.2.1 Load Ratings Where Stability Governs Lifting Performance

(a) For each stipulated operating radius, the load rating is established by taking a percentage of the load that by calculation produces a condition of incipient tipping when the boom is in the least stable direction. Under static conditions, the load ratings shall not exceed 67% of the calculated tipping loads. When wind is considered, if applicable, the combined effects of static and wind loads shall not exceed 77% of the calculated tipping load.

(b) A nonsymmetrical mounting may require a considerably higher loading to produce a tipping condition in a direction other than the least stable direction for which basic load ratings have been established. Therefore, if the crane specification includes ratings for other than the least stable direction, such ratings shall not exceed the applicable tipping percentages.

(c) For a load at any operating radius, stability is affected by the length of boom, jib, or combination of boom and jib mounted, counterweight arrangement, and, when applicable, tower height. The manufacturer shall take these conditions into account when establishing load ratings. Each load rating shall therefore be

determined for the least stable permitted configuration governed by the rating.

(d) Wind forces shall be determined using the maximum operating wind speed applied in the direction least favorable to stability.

(e) For cranes designed to travel with load, inertia forces and forces induced by the maximum allowable track variation from level, as specified by the manufacturer, shall be considered in establishing load ratings.

(f) In addition to the above, the following stipulations shall apply to the establishment of load ratings:

(1) Incipient tipping exists when the algebraic sum of the overturning (tipping) moments equals the sum of the stabilizing moments.

(2) The crane is mounted level, except as in (e) above.

(3) Lifting attachments that are a permanent part of the crane in its working condition shall be considered part of the load for stability calculations whether or not such attachments are part of the published load ratings.

4-1.2.2 Load Ratings Where Factors Other Than Stability Govern Lifting Performance (15)

(a) For each stipulated operating radius, the manufacturer shall ascertain that the crane is capable of supporting rated loads without stresses exceeding predetermined acceptable values. Dynamic effects associated with hoisting and slewing shall be considered, and wind, if applicable, shall be taken in the least favorable direction and at the maximum in-service velocity, as specified by the manufacturer.

(b) Under any condition of loading, stresses may be affected by boom or jib length, counterweight arrangement, tower height (when applicable), swing speed changes and other dynamic effects, hoist line reeving, and hoisting speed range. Therefore, the structural, mechanical, hydraulic, electrical, or pneumatic competence shall be evaluated for the least favorable configuration and operating conditions covered by given load ratings.

(c) A nonsymmetrical mounting may require a considerably higher loading to produce a tipping condition in a direction other than the least stable direction for which basic load ratings have been established. Therefore, if the crane specification includes ratings for other than the least stable direction, such ratings may be governed by structural, mechanical, hydraulic, electrical, or pneumatic competence, in which case, they shall be verified.

(d) For cranes designed to travel with load, inertial forces, and forces induced by the maximum allowable track variation from level, as specified by the manufacturer, shall be considered in establishing structural, mechanical, hydraulic, electrical, or pneumatic competence.

(15) 4-1.2.3 Load Rating Chart

A durable rating chart with legible letters and figures shall be provided with each crane and attached in a location visible to the operator while seated at the controls and at remote-control stations. The content of these charts shall include, but not be limited to, the following:

(a) the crane manufacturer's name, the model and serial number of the crane, and a full and complete range of manufacturer's approved crane load ratings at all stated operating radii for each permitted boom length, jib length, and combination boom and jib (when applicable).

(b) cautionary or warning notes relative to limitations on equipment and operation procedures.

(c) indication of the least stable direction and, in the case of nonsymmetrical mountings with ratings given for other than the least stable direction, the directional limitations applicable to each set of ratings.

(d) recommended parts of hoist reeving, size, and type of rope for various crane loads.

(e) whether hoist-holding mechanism is automatically controlled, manually controlled, and if free fall is available.

(f) advice that slings and lifting attachments are part of the load. If the manufacturer elects to include the lower load block as part of the load, the rating chart shall so state.

(15) 4-1.2.4 Backward Stability

(a) The backward stability of a crane is its ability to resist overturning in the direction opposite the boom point while in the unloaded condition. The minimum acceptable backward stability condition, as determined by calculation, is such that the horizontal distance between the center of gravity of the crane and the axis of rotation shall not exceed 60% of the radial distance from the axis of rotation to the backward tipping fulcrum in the least stable direction.

(b) The general requirements applicable for determination of the backward stability condition are as follows:

(1) crane to be equipped for normal operation with shortest boom permitted (as applicable)

(2) boom or load trolley to be positioned at minimum achievable radius

(3) crane to be unloaded (no hook, block, or attachment weight)

(4) crane standing on level track or foundation

(5) maximum operating wind speed acting in a direction to reduce stability

(15) 4-1.2.5 Out-of-Service Stability

The manufacturer shall ascertain by calculation that in each recommended configuration, traveling cranes shall have a margin of stability against incipient tipping when exposed to wind forces appropriate to the installation site as given in ASCE/SEI 7 when the crane is out

of service. Overturning moments shall not exceed 80% of the stabilizing moments, without consideration of any anchorage devices or rail clamps. For weathervaning cranes, the boom shall be taken in the attitude dictated by its wind area balance; nonweathervaning cranes shall be taken in their least favorable attitude. For fixed cranes, see para. 4-1.1.1(a).

4-1.2.6 Altered (Modified) Cranes**(15)**

Whenever cranes are altered, unless the work is done by the original manufacturer, the owner of the crane shall maintain records of the work performed. The records shall include calculations and drawings prepared and signed by a qualified person that delineate the alterations and that verify that the entire crane and/or the affected components satisfy the applicable portions of this Volume. The calculations shall include a recitation of the engineering criteria governing the design. For all altered cranes, records of tests required under para. 4-2.3.1(a) shall be maintained and should include a description of the tests performed, the rationale for selecting those test conditions, the date and ambient conditions at the time of testing, and the signature of the qualified person who supervised the tests.

SECTION 4-1.3: DOCUMENTATION

Each crane shall be provided with informational literature, including, but not limited to, the following.

4-1.3.1 Site Preparation and Crane Support Design Data

For use of the crane support designers, data such as what is listed below should be provided.

(a) vertical and horizontal forces and torsional and overturning moments applicable to the crane configuration and location of the particular installation; the data should indicate whether governing forces are due to in-service or out-of-service winds and the applicable wind velocities and direction(s); for traveling cranes, the data can be stated in terms of wheel or bogie loads

(b) maximum wind velocity for which traveling cranes possess adequate resistance to sliding, as determined by calculation, in the configuration for the particular installation and precautions that shall be taken to secure cranes at higher wind velocities

(c) rail track installation requirements and tolerances for traveling cranes

(d) anchorage arrangements for cranes to be installed on fixed bases

(e) crane dimensional data

4-1.3.2 Erection Instructions

For the use of crane erection personnel, data such as what is listed below should be provided.

(a) weight and dimensions for components and subassemblies

(b) recommended lifting attachment points, when applicable

(c) center of gravity location for nonuniform components and subassemblies

(d) the method and recommended sequence of assembly, when applicable; warnings should be given alerting erection personnel when member strength or stability requires particular methods or sequencing

(e) details, including diagrams where necessary, of critical component connections describing and identifying bolts, pins, and other parts needed, the method of assembling the joint, the torque or tension to be applied to prestressed bolts, the point in time in the erection process for applying torque or tension, and the means for retaining components such as pins

4-1.3.3 Operating Instructions, Limitations, and Precautions

Information, data, and recommended operating practices shall be provided by the crane manufacturer or a qualified person for use by the crane's operator and supervisory personnel.

4-1.3.4 Maintenance Requirements and Recommendations

This information should include identification of those members or locations it is advisable to periodically observe or test for the purpose of detecting the onset of metal fatigue, the loosening of prestressed bolts, or wear affecting the ability of the crane to support rated loads.

4-1.3.5 Repair Recommendations

If repairs are needed, advice on welding procedures should be provided, if applicable, and the type of metal used for load-sustaining members shall be identified (see para. 4-2.4.4).

4-1.3.6 Design Characteristics Affecting Safety

In addition to the information called for in para. 4-1.3.3, data such as what is listed below should be provided.

(a) location, proper settings and adjustments, and functioning of limiting and indicating devices

(b) location and required settings of hydraulic or pneumatic pressure relief valves and locations of points where circuit pressure can be checked (see para. 4-1.18.8)

(c) limitations on service life of load-bearing members or mechanisms, if applicable, including manufacturer's recommendations for frequency of inspection as a function of severity of service

SECTION 4-1.4: HOISTING EQUIPMENT

4-1.4.1 General Requirements

(a) When using recommended reeving, the load hoist shall be capable of hoisting and lowering rated loads

with operational characteristics required for crane service.

(b) Unless coupled directly, or through a hydrostatic drive, the load hoist mechanism shall be provided with a clutching or power-disengaging device.

(c) Electric-motor-operated cranes that are capable of overspeeding the power plant on overhauling loads shall be provided with overspeed protection.

(d) Hooks shall be provided with latches unless the application makes the use of the latch impractical. When provided, the latch shall bridge the throat of the hook for the purpose of retaining slings, chains, etc. under slack conditions. Refer to ASME B30.10.

4-1.4.2 Hoist Drums

(15)

(a) No fewer than two full wraps of rope shall remain on the drum when the hook is in the extreme low position.

(b) The drum end of the rope shall be attached to the drum as recommended by the crane or rope manufacturer or by a qualified person.

(c) Drum flanges shall at all times during operation extend a minimum of one-half rope diameter but not less than 0.5 in. (13 mm) above the top layer of the rope.

(d) The diameter of the drum shall be sufficient to provide a first layer rope pitch diameter of not less than 18 times the nominal diameter of the rope used.

(e) Positive means, such as an automatic spring-applied electric/pneumatic released brake, controllable from the operator's station, shall be provided to hold the drum from rotating in the lowering direction and be capable of holding the rated load indefinitely without further attention from the operator.

4-1.4.3 Hoist Brakes

(a) A power control braking means, such as regenerative, dynamic counter torque, or eddy current braking or a mechanically, pneumatically, or hydraulically controlled braking means, shall be provided and capable of maintaining controlled lowering speed of rated loads.

(b) The load hoist mechanism shall be equipped with at least one brake having holding capacity of not less than 125% of the full load hoisting torque at the point where the brake is applied.

(c) When power-operated brakes having no continuous mechanical linkage between the actuating and the braking means are used for controlling loads, an automatic means shall be provided to stop and hold the load in the event of loss of brake-actuating power.

(d) When directly coupled electric or hydraulic motor(s) are used for controlling loads, an automatic means shall be provided to stop and hold the load in the event of loss of power or pressure.

(e) When automatic braking means are provided, a means, such as a manual release, should be furnished

to permit controlled lowering of the load in the event of loss of power or pressure.

(f) When provided, foot brake pedals shall be constructed so that the operator's feet will not readily slip off, and a means shall be provided for holding the brakes in the applied position without further attention by the operator.

4-1.4.4 Hoist Sheaves

(a) Sheave grooves shall be free from surface defects that could cause rope damage. The cross-sectional radius at the bottom of the groove should be such as to form a close-fitting saddle for the size of rope used. The sides of the groove shall be tapered outwards to facilitate entrance of the rope into the groove. Flange rims shall run true about the axis of rotation.

(b) Sheaves carrying ropes that can become momentarily unloaded shall be provided with close fitting guards or other suitable devices to guide the rope back into the groove when a load is reapplied.

(c) All sheave bearings shall be provided with means for lubrication, except for those that are permanently lubricated.

(d) The pitch diameters of the upper and lower load block sheaves shall not be less than 18 and 16 times the nominal diameter of the rope used, respectively.

(e) The sheaves in the lower load block shall be equipped with close-fitting guards that will guard against ropes becoming fouled in the sheaves when the block is lying on the ground with ropes loose.

(15) 4-1.4.5 Hoist Ropes

(a) The hoisting rope shall be of a construction recommended for that service by the rope or crane manufacturer or qualified person.

(b) The design factor of hoist ropes shall be not less than 3.5, but when rotation-resistant ropes are used, the design factor shall be 5 or greater. [The design factor of 5 or greater may be modified by the crane user by complying with the provisions of para. 4-3.2.1(a)(4).]

(c) The design factors in the preceding clause shall be the total minimum breaking force of all hoist ropes supporting the load divided by the static load imposed on the hoist ropes.

(d) Rotation-resistant rope shall be given extra care during installation as it may be more easily damaged than other rope.

(e) If a load is supported by more than one part of rope, the tension in the parts shall be equalized.

(f) Socketing shall be done in the manner specified by the manufacturer of the rope or fitting.

(g) For ambient temperatures at the rope in excess of 180°F (82°C), rope having an independent wire rope or wire strand core or other temperature-damage-resistant core shall be used.

SECTION 4-1.5: LUFFING (BOOM HOIST) AND TROLLEY EQUIPMENT

4-1.5.1 General Requirements

(a) When using recommended reeving and with rated loads suspended, the boom hoist shall be capable of raising the boom, holding it stationary without attention from the operator, and lowering it only when coupled to its prime mover or suitable retarder.

(b) Unless coupled directly or through a hydrostatic drive, the boom hoist mechanism shall be provided with a suitable clutching or power-disengaging device.

(c) The boom hoist mechanism shall be equipped with at least one brake having holding capacity of not less than 125% of the full load hoisting torque at the point where the brake is applied.

4-1.5.2 Boom Hoist Drums

(15)

(a) The boom hoist drum(s) shall be provided with an auxiliary ratchet and pawl, or other positive locking device in addition to the brake required by 4-1.5.1(c) to hold the drum(s) from rotating in the lowering direction, hold the rated load indefinitely, and be controllable from the operator's station.

(b) The drum(s) shall have sufficient rope capacity to operate the boom at all positions from horizontal to the highest angle recommended when using the manufacturer's recommended reeving and rope size.

(1) No fewer than two full wraps of rope shall remain on the drum(s) with the boom point lowered to its lowest possible position.

(2) Each drum end of the rope shall be attached to the drum(s) as recommended by the rope or crane manufacturer or by a qualified person.

(c) Drum diameter shall be sufficient to provide a first layer rope pitch diameter of not less than 15 times the nominal diameter of the rope used.

4-1.5.3 Boom Hoist Sheaves

(a) Boom hoist sheaves shall meet the requirements of paras. 4-1.4.4(a) through (c).

(b) Pitch diameters shall not be less than 15 times the nominal diameter of the rope used.

4-1.5.4 Load Trolley Systems

(a) Load trolleys shall be under control when traversing the boom during operations.

(b) The body or frame of the trolley shall be fitted with means to restrain the trolley from becoming detached from its guide rail(s) in the event of trolley wheel or axle breakage or side loading.

(c) The trolley shall be provided with an operating brake capable of stopping the trolley in either direction. The system shall include means for holding the trolley without further action on the part of the operator and shall engage automatically if power or pressure to the brake is lost.

(d) In addition to the operating brake, the trolley shall be equipped with an automatic braking device capable of stopping the outward movement of the load trolley in the event of trolley drive rope breakage, if such ropes are used.

(e) The boom point sheave, if provided, shall have at least one broad stripe of bright, contrasting color on each side so that it can be determined whether or not the sheave is turning. Cheek plates shall be arranged so that the stripe will be visible as the sheave turns.

SECTION 4-1.6 SLEWING (SWING) MECHANISM

4-1.6.1 General Requirements

(a) The swing mechanism shall be capable of smooth starts and stops and of providing varying degrees of acceleration and deceleration.

(b) Cranes required to weathervane when out of service shall be equipped with means controllable from the operator's station that render the rotating upper structure free to rotate.

4-1.6.2 Slewing Brakes and Locking Device

(a) A braking means with holding power in both directions shall be provided to prevent movement of the rotating upper structure during operation and shall be capable of being set in the holding position and remaining so without further action on the part of the operator.

(b) A device for positively locking the rotating upper structure should be provided. When provided, it shall be arranged for avoidance of inadvertent engagement or disengagement. If a positive locking device is provided, a visual or audible indicator shall be furnished to warn the operator of device engagement.

SECTION 4-1.7 TRAVEL EQUIPMENT

(15) 4-1.7.1 General Requirements

(a) Means shall be provided to prevent cranes from running into the buffers or stops while under power.

(b) Drives shall be capable of smooth starts and stops and of providing varying degrees of acceleration and deceleration. Provision should be made in the travel drive(s) to provide power characteristics that permit the crane to travel to a parking area, with or against the wind, if a wind alarm sounds.

(c) A warning signal shall automatically activate whenever the crane travels in order to warn persons in the vicinity.

(d) Means shall be provided to prevent crane travel from the effects of wind per ASCE SEI 7 when the crane is out of service.

4-1.7.2 Travel Trucks

(a) Crane trucks shall be fitted with sweeps extending to the top of the rail and placed in front of the leading wheels in either direction.

(b) Truck wheels shall be guarded.

(c) Means shall be provided to limit the drop of truck frames in case of wheel or axle breakage to a distance that will not cause the crane to overturn.

4-1.7.3 Travel Brakes

(15)

(a) Braking means shall be provided. A brake or other means shall be provided to hold the crane in position when not traveling and to lock the wheels against rotation to resist the effects of in-service wind and operational forces.

(b) Brakes shall automatically engage on loss of power or actuating pressure to the brake and when power is not applied to the travel drive.

SECTION 4-1.8: BRAKES, GENERAL REQUIREMENTS

(a) Brakes shall be arranged to permit adjustment where necessary to compensate for lining wear and maintain force in springs, where used.

(b) Braking means shall have heat dissipation capability consistent with service needs.

(c) Brakes shall be protected from the weather and from lubricants, hydraulic fluid, or other such liquids, and dirt.

(d) Where springs comprise part of the braking mechanism, they shall be subjected to compression only.

SECTION 4-1.9: LIFTING MAGNETS

(15)

Cranes for use with lifting magnets shall have the following:

(a) Separate magnet circuit switch of the enclosed type with provision for locking in the OPEN (OFF) position. The magnet disconnect switch shall be connected on the line side (power-supply side) of the crane disconnect switch.

(b) Means shall be provided for discharging the inductive load of a lifting magnet.

(c) Indication or signal lights should be provided to indicate that power to a lifting magnet is on or off. These lights, if used, shall be visible to the crane operator and persons on the floor.

(d) For a remote operated crane, the loss of the remote signal shall not result in demagnetizing the lifting magnet.

SECTION 4-1.10: OPERATIONAL AIDS

(15)

(a) Indicating devices shall be provided to

(1) display the weight of the load on the hook

(2) display the luffing boom angle and/or operating radius

(3) display ambient wind speed

(4) indicate the rotation of boom and hoist drums

(b) Motion-limiting devices shall be provided to

(1) limit load hoist upward motion to prevent two-blocking

(2) limit load hoist downward motion to maintain the minimum rope on the drum per para. 4-1.4.2(a)

(3) limit boom hoist upward operation to prevent boom upper limit overtravel

(4) limit boom hoist downward motion to maintain the minimum rope on the drum per para. 4-1.5.2(b)(1)

(5) limit crane travel at both ends of the running tracks

(6) limit the weight of the load lifted

(7) limit operating radius in accordance with crane's rated capacity, i.e., load moment

(8) limit pressures in hydraulic or pneumatic circuits (see para. 4-1.18.8)

(c) Motion-limiting devices such as in (b) above should be provided with means to permit the operator to override them under controlled conditions.

(d) Motion-limiting devices that do not provide means to permit the operator to override them under any condition

(1) Boom stops and bumpers shall be provided for cranes or boom elevation cylinders that limit the angle of the boom.

(2) Jibs shall be restrained from backward overturning.

(15) SECTION 4-1.11: BOOM AND JIB SUPPORT ROPES

(a) For standing ropes supporting booms or jibs, the minimum design factor shall be 3.0; for running ropes, the minimum design factor shall be 3.5. Rotation-resistant ropes and fiber core ropes shall not be used.

(b) Standing ropes that are used as live ropes during erection, and boom hoist running ropes, shall have a minimum design factor of 3.0 for the loads occurring during erection but shall comply with (a) above for the erected condition.

(c) The design factors in the preceding clauses shall be the total minimum breaking force of all the ropes supporting the boom or jib divided by the static load imposed on those ropes when supporting the weight of the boom or jib structure and rated loads.

(d) Sheaves used during erection and dismantling that remain in the support system shall comply with para. 4-1.5.3.

(e) Any new poured socket or swaged socket assembly used as a boom pendant shall be proof tested to the crane or fitting manufacturer's recommendation but in no case greater than 50% of the component wire rope's or structural strand's nominal strength.

SECTION 4-1.12: REEVING ACCESSORIES

(a) Eye splices shall be made in a manner recommended by the rope or crane manufacturer, or by a qualified person, and rope thimbles should be used in the eye.

(b) Wire rope clips shall be drop-forged steel of the single-saddle (U-bolt) or double-saddle type clip. Malleable cast iron clips shall not be used. For spacing, number of clips, and torque values, refer to the clip manufacturer's recommendation. Wire rope clips attached with U-bolts shall have the U-bolt over the dead end of the rope and the live rope resting in the clip saddle. Clips shall be tightened evenly to the recommended torque. After the initial load is applied to the rope, the clip nuts shall be retightened to the recommended torque to compensate for any decrease in rope diameter caused by the load. Rope clip nuts should be retightened periodically to compensate for any further decrease in rope diameter during usage.

(c) Swaged, compressed, or wedge socket fittings shall be applied as recommended by the rope, crane, or fitting manufacturer or a qualified person.

(d) Wire rope clips used in conjunction with wedge sockets shall be attached to the unloaded dead end of the rope only (see Fig. 4-1.12-1).

SECTION 4-1.13: COUNTERWEIGHTS

(a) Crane superstructures shall be arranged to receive counterweights, made in accordance with the crane manufacturer's specifications, and to hold them in position with means provided to guard against shifting or dislodgement during crane operation.

(b) Movable counterweights, if provided, shall either move automatically or shall be equipped with a position indicator with readout at the operator's station(s). When counterweight position is controlled by ropes, means shall be provided to prevent uncontrolled movement in the event of rope breakage.

SECTION 4-1.14 CONTROLS

4-1.14.1 Crane Function Controls

(15)

(a) At the operator's station, all controls used during the crane operating cycle shall be located within reach of the operator. Controls shall have legible markings or symbols to indicate their function and, where appropriate, the direction of the motion imparted.

(b) Controls for hoisting, luffing, trolleying, slewing, and travel shall cut off power to the motion drive when engagement pressure is released, unless intentionally restrained for functional purposes.

(c) Remote-operated cranes shall function so that if the control signal for any crane motion becomes ineffective, that crane motion shall stop.

Fig. 4-1.12-1 Wedge Sockets

(15)

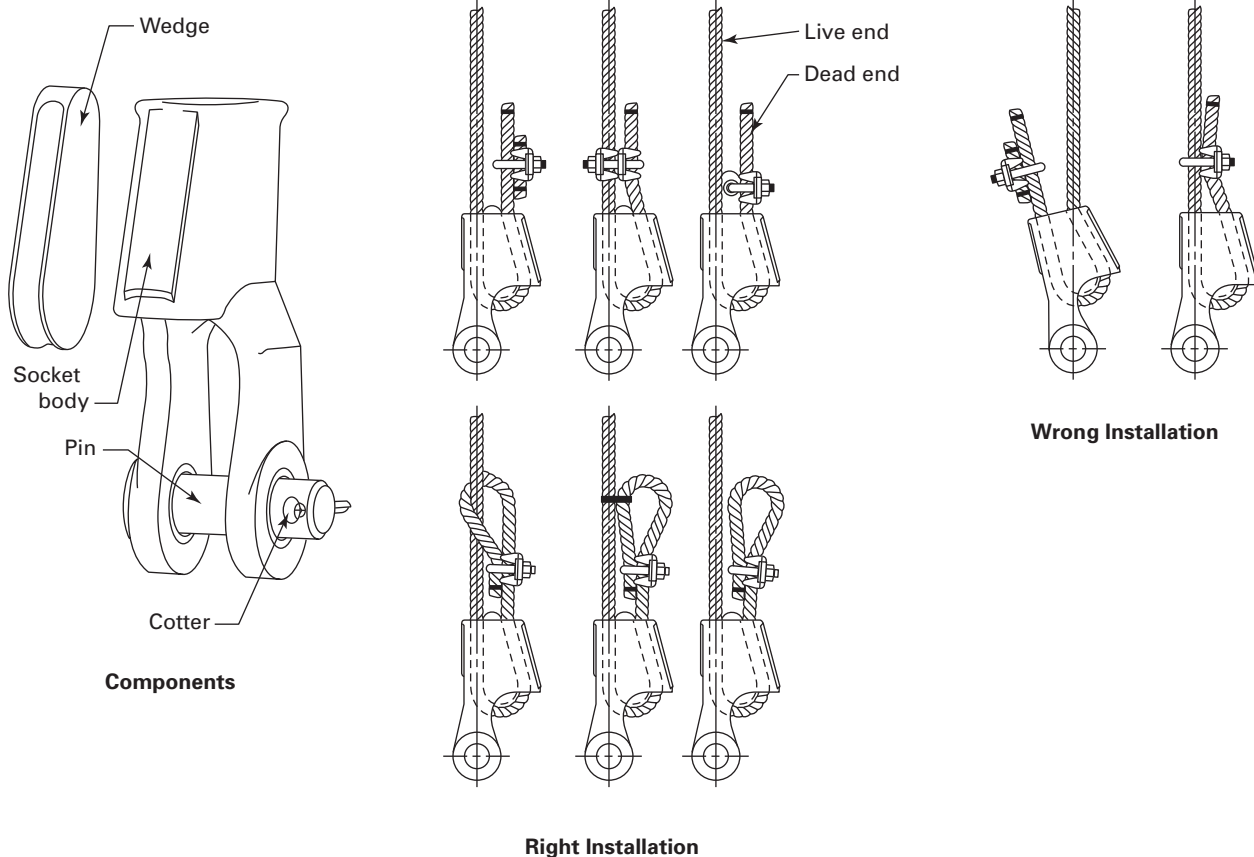

(d) Electric-motor-operated cranes shall be provided with a device that will disconnect all motors from the line on failure of power and will not permit any motor to be restarted until the control is brought to the OFF position or a reset switch or button is operated.

(e) Electric-motor-operated cranes shall be provided with means for the operator to interrupt the main power circuit from the operating position.

(f) Remote-control stations shall include provisions for emergency stop in the event of a device malfunction.

(g) Provisions shall be made to prevent simultaneous activation of controls when more than one operator's station (remote control) is provided.

(h) Where cranes are powered by hydraulic motors, means shall be provided to automatically stop the power plant on loss of hydraulic pressure.

4-1.14.2 Power Plant Controls

(a) All cranes powered by internal combustion engines with a direct mechanical or hydrodynamic (such as a torque converter or fluid coupling) drive to any crane function shall be provided with a clutch or other

means for disengaging power. The control shall be within reach of the operator's station.

(b) Controls for operating the power plant shall be within reach of the operator and shall include, as applicable

(1) means to start and stop, with provisions to lock in the stop position

(2) means to control speed of internal combustion engines

(3) means to stop internal combustion engines under emergency conditions

(4) means for shifting selective transmissions

4-1.14.3 Control Forces and Movements

(a) Forces to operate shall not be greater than 35 lb (156 N) on hand levers and not greater than 50 lb (225 N) nor less than 8 lb (35 N) on foot pedals.

(b) Travel distance on hand levers shall not be greater than 14 in. (360 mm) from the neutral position on two-way levers and shall not be greater than 24 in. (610 mm) on one-way levers. Travel distance on foot pedals shall not be greater than 10 in. (260 mm).

(15) SECTION 4-1.15: TRANSLATIONS OF SAFETY-RELATED INFORMATION AND CONTROL DESIGNATIONS

(a) Translation of non-English documentation into English

(1) The wording of written non-English safety information and manuals regarding use, inspection, and maintenance shall be translated onto English by professional translation industry standards, which include, but are not limited to, the following:

(-a) translation of the complete paragraph message, instead of word by word

(-b) grammatical accuracy

(-c) respectfulness of the source document content without omitting or expanding the text

(-d) accurate translation of the terminology

(-e) reflection of the level of sophistication of the original document

(2) The finished translation shall be verified for compliance with (a)(1)(-a) through (a)(1)(-e) above by a qualified person having an understanding of the technical content of the subject matter.

(3) Pictograms used to identify controls shall be described in the manuals. The pictograms should comply with ISO 7000, ISO 7296, or another recognized source, if previously defined. The text of the descriptions shall meet the criteria of (a)(1) and (a)(2) above.

(b) Any non-English documentation provided in addition to English shall be translated and reviewed in accordance with the requirements listed above.

SECTION 4-1.16: ELECTRICAL EQUIPMENT

4-1.16.1 General Requirements

(a) Each electrically powered crane shall have a main disconnect switch mounted at or near the initial base of the crane. This switch shall have provisions for locking in the OFF position.

(b) Electrical equipment shall be so located or guarded that live parts are not exposed to inadvertent contact under normal operating conditions.

(c) Electrical equipment shall be protected from dirt, grease, oil, and moisture. Fixtures, wiring, and connections exposed to the weather shall be of weather-resistant type.

(d) Wiring shall comply with the provisions of ANSI/NFPA 70 for temporary wiring. Motors, controls, switches, and other electrical equipment shall meet the applicable requirements of ANSI/NFPA 70. Hoist, swing, trolley, and travel controllers shall conform to ANSI/NEMA ICS3, Part ICS 3-443.

(e) Provisions shall be made to guard against reversing of each motor due to reversed phase connections.

(f) Electrical circuits between the fixed and rotating portions of the crane shall pass through connections that

permit continuous rotation in either direction unless other means are provided to prevent damage to the electrical conductors.

(g) Individual overload protection shall be provided for each motor.

(h) Lightning protection shall be provided.

4-1.16.2 Resistors

(a) Resistors shall be of corrosion-resistant material. If guarded or enclosed, provision shall be made for ventilation to forestall overheating. Resistors shall be installed with consideration for avoiding the accumulation of combustible matter.

(b) Resistor units shall be supported to minimize vibration.

SECTION 4-1.17 OPERATOR'S CABS

4-1.17.1 Construction

(15)

(a) An operator's cab shall be provided. It shall be constructed of materials that do not support combustion and shall have means for ventilation.

(b) An adjustable operator's seat with backrest shall be provided. The seat should be arranged and constructed to minimize operator fatigue.

(c) Where necessary, areas of the cab roof shall be capable of supporting, without permanent distortion, the weight of a 200-lb (90-kg) person.

(d) Cab doors, whether of the swinging or sliding type, shall be restrained from inadvertently opening or closing during travel or operation of the crane.

(e) All cab glazing shall be safety glazing material as defined in ANSI/SAE Z26.1. Windows shall be provided in the front and on both sides. Forward visibility should include a vertical range to cover the hook block and pickup points on the ground. Windows provided with openable portions shall be arranged to prevent inadvertent closure during operation. A windshield wiper should be provided on the front window.

(f) Means shall be provided for cleaning windows from inside the cab unless exterior platforms are provided.

(g) Cab lighting, either natural or artificial, shall provide a level of illumination that enables the operator to observe the operating controls.

4-1.17.2 Access

(15)

(a) Stairs or access ladders to the cab, machinery platforms, and tower shall be provided. Ladders shall conform to ANSI/ALI A14.3 or to ANSI/SAE J2703, as applicable.

(b) Outside platforms shall have walking surfaces of a skid-resistant type, shall be provided with standard handrails, and shall conform to ANSI A1264.1.

(c) When it is necessary to climb more than 120 ft (37 m) of vertical ladder in the crane tower to reach the

cab or machinery deck, consideration should be given to providing a powered means of access in addition to ladders.

(d) When access to the operator's cab requires a climb of 100 ft (30 m) or more, sanitary facilities should be provided.

4-1.17.3 Toolbox

A metal receptacle should be provided for the storage of small hand tools and lubricating equipment. It should be secured in the cab or on the machinery platform.

4-1.17.4 Fire Extinguisher

A portable fire extinguisher, with a basic minimum extinguisher rating of 10 BC, shall be installed in the cab or at the machinery housing.

4-1.17.5 Signal Device

An audible signal device should be provided with the control located within reach of the operator.

SECTION 4-1.18: GENERAL REQUIREMENTS

4-1.18.1 Footwalks and Ladders

(a) To provide access to the boom and its attachments such as connections, limiting devices, sheaves, rope, and fittings, a footwalk with skid-resistant surface and with handrails or holding lines should be provided. Other means for access should be provided on booms too small for footwalks. Footwalks, when provided, should be 18 in. (450 mm) or more in width.

(b) When top towers or A-frame gantries include items requiring inspection or routine maintenance, ladders, handgrips, and, if necessary, platforms with skid-resistant surfaces and with railings shall be provided.

(c) When it is necessary to periodically check or adjust the tension of slewing ring-bearing attachment bolts, access shall be provided, including work platforms with railings, where needed.

(d) Footwalks, platforms, ladders, and railings shall be capable of supporting the weight of a 200-lb (90-kg) person without permanent distortion. Holding lines should be installed so as not to deflect laterally more than 6 in. (150 mm) when a 200-lb (900-N) lateral force is applied.

4-1.18.2 Guards for Moving Parts

(a) Exposed moving parts, such as gears, projecting set screws and keys, drive chains and sprockets, and reciprocating or rotating parts, which might constitute

a hazard under normal operating conditions, shall be guarded.

(b) Each guard shall be capable of supporting the weight of a 200-lb (90-kg) person without permanent distortion, unless the guard is located where it is not reasonable to expect a person to step during operation or maintenance.

4-1.18.3 Lubrication Points

Lubrication points should be accessible without the necessity of removing guards or other parts with tools unless equipped for centralized lubrication.

4-1.18.4 Exhaust Gases

Engine exhaust gases shall be piped and discharged away from the operator. Exhaust pipes shall be guarded or insulated to prevent contact by personnel when performing normal duties.

4-1.18.5 Clutch Protection and Adjustment

(a) Dry friction clutches shall be protected against rain and other liquids, such as oil and lubricants.

(b) Clutches shall be arranged to permit adjustments where necessary to compensate for wear.

4-1.18.6 Wind Velocity Device

A wind velocity-indicating device should be provided and mounted at or near the top of the crane. The velocity readout should be at the operator's station in the cab, and a visible or audible alarm should be triggered in the cab and at remote-control stations when a preset wind velocity has been exceeded.

4-1.18.7 Fuel Filler Pipes

Fuel tank filler pipes shall be located or protected so as not to allow spillage or overflow to run onto the engine, exhaust, or electrical equipment of the machine being fueled.

4-1.18.8 Hydraulic and Pneumatic Pressures

(a) Relief valves shall be provided in hydraulic and pneumatic circuits carrying fluid pressurized by a power driven pump in order to limit the maximum pressure in the circuit. The magnitude of the relief settings shall permit operation under rated load conditions, and means shall be provided to prevent unauthorized adjustment or tampering.

(b) Means shall be provided for checking manufacturer's specified pressure settings in each circuit.

Chapter 4-2

Inspection, Testing, and Maintenance

SECTION 4-2.1: INSPECTION

(15) 4-2.1.1 General

All inspections shall be performed by designated persons. Any deficiencies identified shall be examined and a determination made by a qualified person as to whether they constitute a hazard and, if so, what additional steps need to be taken to address the hazard.

(15) 4-2.1.2 Inspection Classification

(a) *Initial Inspection.* Prior to initial use, all new, reinstalled, altered, or extensively repaired cranes shall be inspected to verify compliance with the applicable provisions of this Volume.

(b) *Regular Inspection.* Inspection procedures for cranes in regular service are divided into two general classifications based on the intervals at which inspection should be performed. The intervals in turn are dependent upon the nature of the critical components of the crane and the degree of the exposure to wear, deterioration, or malfunction. The two general classifications are designated as frequent and periodic with respective intervals between inspection as defined below.

(1) *Frequent Inspection.* Visual examination with records not required.

(-a) light service — monthly

(-b) normal service — weekly to monthly

(-c) heavy service — daily to weekly

(2) *Periodic Inspection.* Visual inspection at 1- to 12-month intervals or as specifically recommended by the manufacturer. Records shall be kept of apparent external conditions to provide a basis for continuing evaluation.

(15) 4-2.1.3 Frequent Inspection

Items such as the following shall be inspected at intervals defined in para. 4-2.1.2(b)(1) or as specifically indicated, including observation during operation for impairments that might appear between regular inspections.

(a) all control mechanisms for maladjustment interfering with proper operation — daily, when in use

(b) all control mechanisms for legible markings, excessive wear of components, and contamination by lubricants or other foreign matter

(c) all crane function-operating mechanisms for maladjustment interfering with proper operation and excessive wear of components

(d) motion-limiting devices for proper operation with the crane unloaded; each motion should be inched into its limiting device or run in at slow speed with care exercised

(e) operational aids for malfunction or inaccuracies — daily, when in use

(f) all hydraulic and pneumatic hoses, particularly those that flex in normal operation

(g) electrical apparatus for malfunctioning, signs of excessive deterioration, dirt, and moisture accumulation

(h) hooks and latches for deformation, chemical damage, cracks, and wear (refer to ASME B30.10)

(i) braces supporting crane masts (towers) and anchor bolt base connections for looseness

(j) hydraulic system for proper fluid level — daily when in use

(k) structural members for damage or deformation

4-2.1.4 Periodic Inspection

(15)

(a) Complete inspections of the crane shall be performed at intervals, as generally defined in para. 4-2.1.2(b)(2) depending upon its activity, severity of service, and environment or as specifically indicated below.

(1) light service — annually

(2) normal service — semiannually to annually

(3) heavy service — quarterly

(b) These inspections shall include the requirements of para. 4-2.1.3 and, in addition, items such as the following:

(1) deformed, cracked, or corroded members and welds in the crane structure and boom

(2) loose bolts or rivets

(3) cracked or worn sheaves and drums

(4) worn, cracked, or distorted parts, such as pins, bearing, shafts, gears, rollers, locking and clamping devices, sprockets, and drive chains or belts

(5) excessive wear on brake and clutch system parts, linings, pawls, and ratchets

(6) load, wind, and other indicators for inaccuracies outside the tolerances recommended by the manufacturer

(7) power plants for performance and compliance with safety requirements

(8) electrical apparatus for signs of deterioration in controllers, master switches, contacts, limiting devices, and controls

(9) crane hooks inspected per ASME B30.10

(10) load blocks for cracks, deformation, and excessive wear

(11) travel mechanisms for malfunction, excessive wear, or damage

(12) hydraulic and pneumatic pumps, motors, valves, hoses, fittings, and tubing for excessive wear or damage

(c) Any deficiencies, such as those listed above, shall be examined and a determination made as to whether disassembly is required for additional inspection.

(d) Visual inspection of members and their connections (see para. 4-1.3.4) shall be performed at intervals specified in (a) above. Observed signs of possible damage may indicate the need to remove paint or use other than visual nondestructive examination techniques to permit determination as to whether a hazard exists. For cranes with 10 yr or more of service other than light service, a visual inspection, in place of an inspection specified in (a) above, should be performed at annual intervals. The additional purpose of this inspection is to consider whether the observed condition of the crane calls for the use of more stringent examination techniques. The recommendations of the manufacturer in this regard shall be considered.

(e) High-strength (traction) bolts used in connections and at the slewing bearing shall be checked for proper tension (torque) at intervals recommended by the crane or bearing manufacturer or as suggested in (a) above. Bolts that loosen should be checked for permanent deformation or other damage. Visible cracks, difficulty in threading or unthreading a nut by hand, or observable necking are reason for replacement.

(f) Sheaves used in the hoisting system shall be checked for cracks in the flanges and spokes. When external evidence of defects exists, it may be necessary to remove the sheave from its mounting for this purpose.

4-2.1.5 Cranes Not in Regular Use

(a) A crane, other than a standby crane, that has been idle for a period of 1 month or more, but less than 12 months, shall be inspected in accordance with paras. 4-2.1.3 and 4-2.5.2(a) before being placed in service.

(b) A crane that has been idle for more than 12 months shall be inspected in accordance with paras. 4-2.1.4 and 4-2.5.2(b) before being placed in service.

(c) Standby cranes, before being used, shall be inspected in accordance with the requirements of (a) or (b) above, depending on the interval since they were last used. When such cranes are exposed to adverse environments, they should be inspected more frequently.

(15) SECTION 4-2.2: OPERATIONAL AIDS

(a) Prior to daily operation, operational aids shall be checked in accordance with the device/crane manufacturer's recommended procedures to determine if they are functioning properly.

(b) Operational aids shall be inspected and tested in accordance with the device/crane manufacturer's recommended procedures as part of the periodic inspection of para. 4-2.1.4.

(c) When operational aids are inoperative or malfunctioning, the crane and/or device manufacturer's recommendations for continued operation or shutdown of the crane shall be followed until the aids are restored to proper operation. Without such recommendations and any prohibitions for the manufacturer against further operation, the requirements of para. 4-3.2.1(b) shall apply.

SECTION 4-2.3: TESTING (15)

4-2.3.1 Operational Tests

(a) Prior to initial use, newly erected cranes shall be tested in accordance with para. 4-1.1.3. Altered cranes shall be tested, under the direction of a qualified person, to verify compliance in accordance with paras. 4-1.1.3(d) through (f).

(b) Prior to initial use, repaired cranes shall be tested as determined by a qualified person. Testing may be limited to the function(s) affected by the repair. When a rated load test is required, it shall be in accordance with para. 4-2.3.2.

4-2.3.2 Rated Load Test

Prior to initial use, or after being altered, cranes shall be load tested under the direction of a qualified person. Test loads shall not be less than 100% or more than 110% of rated load, unless otherwise recommended by the manufacturer or a qualified person. Test radii and boom azimuths shall be chosen so as to place maximum loading on the relevant crane parts.

4-2.3.3 Test Records

Signed and dated test records shall be made and kept available for all tests of new, repaired, or altered cranes required under paras. 4-2.3.1 and 4-2.3.2. At a minimum, the records should describe the test(s) performed, the loads, radii, and azimuths of the tests as applicable, the rationale for testing conditions and procedures adopted, and the name(s) of the qualified person(s) making the determinations and directing the tests.

SECTION 4-2.4: MAINTENANCE

4-2.4.1 Preventive Maintenance (15)

(a) The manufacturer shall furnish operation and maintenance information (paras. 4-1.3.3 through 4-1.3.6). A preventive maintenance program shall be established and should be based on the recommendations of the crane manufacturer or a qualified person. Dated records should be kept available.

(b) Replacement parts shall be at least equal to the original manufacturer's specifications.

4-2.4.2 Maintenance Procedure

(a) Before major adjustments or repairs are started, the following precautions shall be taken:

(1) A traveling-type crane to be repaired should be moved to a location where it will cause the least interference with other cranes and operations in the area.

(2) All controllers shall be at the OFF position.

(3) The main or emergency switch shall be open and locked in the OPEN position, except for test purposes.

(4) Warning or OUT OF ORDER signs shall be placed by appointed personnel.

(5) Where other cranes are in operation on the same runway, rail stops or other suitable means shall be provided to prevent interference with the idle crane.

(6) Where temporary protective rail stops are not available, or practical, a signalperson shall be placed at a visual vantage point for observing the approach of an active crane and warning its operator.

(b) After adjustments or repairs have been made, the crane shall not be returned to service until all guards have been reinstalled, limiting and protective devices reactivated, trapped air removed from hydraulic systems, and maintenance equipment removed. Warning or OUT OF ORDER signs shall be removed by appointed personnel only.

4-2.4.3 Adjustments and Repairs

(a) Any hazardous condition disclosed by the inspection requirements of Section 4-2.1 shall be corrected before operation of the crane is resumed. Adjustments and repairs shall be performed only by designated personnel.

(b) Adjustments shall be maintained to ensure correct functioning of components. The following are examples:

- (1) functional operating mechanisms
- (2) limiting devices
- (3) control systems
- (4) braking systems
- (5) power plants

(c) Repairs or replacements shall be provided as needed for operation. The following are examples:

(1) crane hooks showing defects described in para. 4-2.1.3(h) shall be taken out of service; repairs by welding or reshaping are not recommended.

(2) critical parts that are cracked, broken, bent, or excessively worn or corroded.

(3) pitted or burned electrical contacts should be corrected only by replacement and in sets. Controller parts should be lubricated as recommended by the manufacturer or a qualified person.

(d) Remote-control stations shall be kept clean with function identification labels legible.

4-2.4.4 Welded Construction

Welding procedures and welding operator qualifications for use in repair or alteration of load-sustaining members shall be in accordance with ANSI/AWS D14.3 or ANSI/AWS D1.1. Where special steels or other materials are used, the manufacturer shall provide welding procedure instructions. The type of metal used for load-sustaining members shall be identified by the manufacturer (see para. 4-1.3.5).

4-2.4.5 Lubrication

(15)

(a) All moving parts of the crane, for which lubrication is specified, should be regularly lubricated. Lubricating systems should be checked for delivery of lubricant. Care should be taken to follow manufacturer's recommendations as to points of lubrication, maintenance of lubricant levels, and types of lubricant to be used.

(b) Machinery should be stationary while lubricants are being applied and protection provided as called for in paras. 4-2.4.2(a)(1) through (a)(6), unless equipped for automatic lubrication.

SECTION 4-2.5: ROPE INSPECTION, REPLACEMENT, AND MAINTENANCE

(15)

4-2.5.1 General

All inspections shall be performed by designated persons. Any deficiencies identified shall be examined and a determination made by a qualified person as to whether they constitute a hazard.

4-2.5.2 Inspection

(a) Frequent Inspection

(1) All running ropes should be visually inspected once each working day.

(2) Counterweight movement ropes, if provided, should be visually inspected at least once a month.

A visual inspection shall consist of observation of all rope that can reasonably be expected to be in use during the day's operations. These visual observations should be concerned with discovering gross damage, such as listed below, which may be an immediate hazard. When such damage is discovered, the rope shall either be removed from service or inspected as outlined in (b) below.

(-a) distortion of the rope, such as kinking, crushing, unstranding, birdcaging, main strand displacement, or core protrusion; loss of rope diameter in a short rope length or unevenness of outer strands provide evidence that rope replacement should be considered

(-b) general corrosion

(-c) broken or cut strands

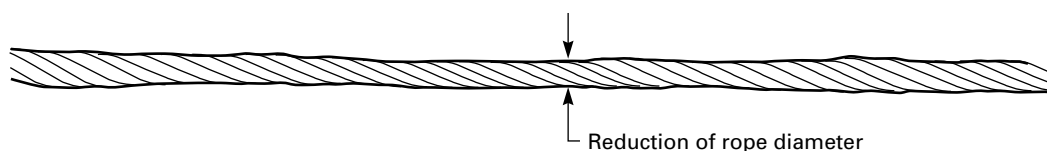
Fig. 4-2.5.2-1 Core Failure in 19 × 7 Rotation-Resistant Rope

GENERAL NOTE: Note the lengthening of lay and reduction of diameter.

(-d) number, distribution, and type of visible broken wires [see paras. 4-2.5.3(b)(1) and (b)(5) for further guidance]

(-e) core failure in rotation-resistant ropes (see Fig. 4-2.5.2-1)

(3) Particular care shall be taken when inspecting boom hoist ropes and sections of rope subject to rapid deterioration, such as flange points, crossover points, and repetitive pickup points on drums.

(4) Particular care shall be taken when inspecting rotation-resistant ropes because of their susceptibility to damage from handling and misuse and potential for deterioration when used on equipment with limited design parameters.

Internal deterioration of rotation-resistant ropes may not be readily observable.

(b) *Periodic Inspection*

(1) Inspection frequency shall be determined by a qualified person and shall be based on such factors as expected rope life as determined by experience on the particular installation or similar installations, severity of environment, percentage of lifts at maximum rating, frequency rates of operation, and exposure to shock loads. Inspections need not be at equal calendar intervals and should be more frequent as the rope approaches the end of its useful life. However, this inspection shall be made at least annually.

(2) These inspections shall cover the entire length of the rope. Any deterioration resulting in appreciable loss of original strength, such as described below, shall be noted and determination made as to whether further use of the rope would constitute a hazard.

(-a) points listed in (a) above

(-b) reduction of rope diameter due to loss of core support or internal or external corrosion

(-c) severely corroded or broken wires at end connections

(-d) severely corroded, cracked, bent, worn, or improperly applied end connections

(3) Care shall be taken when inspecting rope sections subject to rapid deterioration, such as the following:

(-a) sections in contact with saddles, equalizer sheaves, or other sheaves where rope travel is limited

(-b) sections of the rope at or near terminal ends where corroded or broken wires may protrude

(-c) sections subject to reverse bends

(-d) sections of rope that are normally hidden during routine visual inspection, such as parts passing over sheaves

4-2.5.3 Rope Replacement

(a) No precise rules can be given for determination of the exact time for rope replacement, since many variable factors are involved. Once rope reaches any one of the specified criteria, it may be allowed to operate to the end of the work shift, based on the judgment of a qualified person. The rope shall be replaced prior to the next use of the equipment.

(b) Removal criteria for rope replacement shall be as follows:

(1) *Broken Wires*

(-a) in running ropes, six randomly distributed broken wires in one lay or three broken wires in one strand in one lay

(-b) in rotation-resistant ropes, two randomly distributed broken wires in six-rope diameters or four randomly distributed broken wires in 30-rope diameters

(-c) in standing ropes, three or more broken wires in one-rope lay anywhere in the wire rope

(2) one outer wire broken at the contact point with the core of the rope indicated by an externally protruding wire or loop of loose wire

(3) kinking, crushing, birdcaging, or any other damage resulting in distortion of the rope structure

(4) evidence of heat damage from any cause

(5) reductions from nominal rope diameter of more than 5%

(6) Attention shall be given to end connections. Upon development of two or more broken wires adjacent to a socketed end connection, the rope shall be resocketed or replaced. Resocketing shall not be attempted if the resulting rope length will be insufficient for proper operation.

(c) Broken wire removal criteria cited in this Volume apply to wire rope operating on multilayer drums, regardless of sheave material. The user shall contact the sheave, drum, or crane manufacturer or a qualified person for broken wire removal criteria for wire ropes operating on sheaves and single layer drums made of material other than steel.

(d) Replacement rope and connections shall have a strength rating at least as great as the original rope and

connections furnished by the manufacturer. Any deviation from the original size, grade, or construction shall be specified by a rope manufacturer, the hoist manufacturer, or a qualified person.

(e) *Ropes Not in Regular Use.* All rope that has been idle for a period of 1 month or more due to shutdown or storage of the crane on which it is installed shall be inspected in accordance with para. 4-2.1.5 before it is placed in service. Inspections under para. 4-2.1.5(b) shall be for all types of deterioration and shall be performed by an appointed or authorized person.

(f) *Inspection Records*

(1) Frequent inspection — no records required.

(2) Periodic inspection — in order to establish data as a basis for judging the proper time for replacement, a dated report of rope condition shall be kept on file. This report shall cover points of deterioration listed in para. 4-2.5.2(b)(2). If the rope is replaced, only that fact need be recorded.

(g) A long-term inspection program should be established to include records on examination of ropes removed from service to establish a relationship between visual observation and actual condition of the internal structure.

4-2.5.4 Rope Maintenance

(a) Rope should be stored in such a manner as to minimize damage or deterioration.

(b) Rope shall be unreeled or uncoiled in such a manner as to avoid kinking of or inducing a twist in the rope.

(c) Before cutting rope, seizings shall be placed on each side of the place where the rope is to be cut to prevent unlaying of the strands.

(d) During installation, care should be exercised to avoid dragging the rope in dirt or around objects that will scrape, nick, crush, or induce sharp bends in it.

(e) Rope should be maintained in a well-lubricated condition. Lubricant applied as part of a maintenance program shall be compatible with the original lubricant, and, to this end, the rope manufacturer should be consulted; lubricant shall be of a type that does not hinder visual inspection. Those sections of rope that are located over sheaves or otherwise hidden during inspection and maintenance require special attention during lubrication. The object of rope lubrication is to reduce internal friction and to inhibit corrosion.

(f) When an operating rope shows greater wear at well-defined localized areas than on the remainder of the rope, rope life can be extended, in cases where a reduced rope length is adequate, by cutting off a section at the worn end and thus shifting the wear to different areas of the rope.

Chapter 4-3

Operation

(15) **SECTION 4-3.1: QUALIFICATIONS AND RESPONSIBILITIES**

(15) **4-3.1.1 Operators**

(a) Cranes shall be operated only by the following qualified personnel:

(1) designated persons.

(2) trainees under the supervision of a designated person. The number of trainees permitted to be supervised by a single designated person, the physical location of the designated person while supervising, and the type of communication required between the designated person and trainee shall be determined by a qualified person.

(3) maintenance and test personnel, when it is necessary in the performance of their duties.

(4) inspectors (crane).

(b) No one, other than personnel specified in (a) above, shall enter a crane cab with the exception of persons such as oilers, supervisors, and those specific persons authorized by supervisors whose duties require them to do so and then only in the performance of their duties and with the knowledge of the operator.

4-3.1.2 Qualifications for Operators

(a) Operators shall be required by the employer to pass a practical operating examination. Examination shall be limited to the specific type of crane that will be operated.

(b) Operators and operator trainees shall meet the following physical qualifications unless it can be shown that failure to meet the qualifications will not affect the operation of the crane. In such cases, specialized clinical and/or medical judgments and tests may be required.

(1) Have vision of at least 20/30 Snellen in one eye and 20/50 in the other, with or without corrective lenses.

(2) Be able to distinguish colors, regardless of position, if color differentiation is required for operation.

(3) Hearing, with or without hearing aid, shall be adequate to meet operational demands.

(4) Have sufficient strength, endurance, agility, coordination, and speed of reaction to meet the demands of equipment operation.

(5) No evidence of physical defects, or emotional instability that could pose a hazard to the operator or others, or, which in the opinion of the examiner could interfere with the operator's performance. Such evidence may be sufficient reason for disqualification. In such

cases, specialized clinical or medical judgments and tests may be required.

(6) No evidence of being subject to seizures or loss of physical control. Such evidence shall be sufficient reason for disqualification. Specialized medical tests may be required to determine these conditions.

(7) Operators and operator trainees should have normal depth perception, field of vision, reaction time, manual dexterity, coordination, and no tendencies to dizziness or similar undesirable characteristics.

(8) A negative result on a substance abuse test. The level of testing will be determined by the current standard practice for the industry where the crane is employed, and the test results shall be confirmed by a recognized laboratory service.

(c) Operator requirements shall include, but not be limited to, the following:

(1) evidence of successfully passing a physical examination as defined in (b) above

(2) satisfactory completion of a written examination covering operational characteristics, controls, and emergency control skills, such as response to fire or control malfunction, as well as characteristic and performance questions appropriate to the crane type for which qualification is being sought

(3) demonstrated ability to read, write, comprehend, and use arithmetic and a load/capacity chart in the English language

(4) satisfactory completion of a combination written and verbal test on load/capacity chart usage that covers a selection of the configurations the crane may be equipped to handle, for the crane type for which qualification is being sought

(5) satisfactory completion of testing by appropriate written, oral, or practical methods demonstrating proficiency in operating the specific crane type, including prestart and poststart inspections, shutdown, and securing procedures

(6) demonstrated understanding of the applicable sections of the B30 Standard and federal, state, and local requirements

(d) Operators who have successfully qualified to operate a specific crane type shall be required to be requalified if supervision deems it necessary. Requalification shall include, but not be limited to, requirements in (c)(1) through (c)(5) above.

(15) 4-3.1.3 Responsibilities

While the organizational structure of various projects may differ, the following roles are described here for purposes of delineating responsibilities. All responsibilities listed below shall be assigned in the worksite organization. (A single individual may perform one or more of these roles.)

(a) *crane operator*: directly controls the crane's functions.

(b) *crane owner*: has custodial control of a crane by virtue of lease or ownership.

(c) *crane user*: arranges the crane's presence on a worksite and controls its use there.

(d) *lift director*: directly oversees the work being performed by a crane and the associated rigging crew.

(e) *site supervisor*: exercises supervisory control over the worksite on which a crane is being used and over the work that is being performed on that site.

4-3.1.3.1 Responsibilities of the Crane Owner and Crane User. In some situations, the owner and user may be the same entity and is therefore accountable for all of the following responsibilities. In other cases, the user may lease or rent a crane from the owner without supervisory, operational, maintenance, support personnel, or services from the owner. In these situations, paras. 4-3.1.3.1.1 and 4-3.1.3.1.2 shall apply.

4-3.1.3.1.1 The crane owner's responsibilities shall include the following:

(a) providing a crane that meets the requirements of Chapters 4-1 and 4-2, as well as specific job requirements defined by the user

(b) providing a crane and all necessary components, specified by the manufacturer, that meets the user's requested configuration and capacity

(c) providing all applicable load/capacity chart(s) and diagrams

(d) providing additional technical information pertaining to the crane, necessary for crane operation, when requested by the crane user

(e) providing field assembly, disassembly, operation, maintenance information, and warning decals and placards installed as prescribed by the crane manufacturer

(f) establishing an inspection, testing, and maintenance program in accordance with Chapter 4-2 and informing the crane user of the requirements of this program

(g) designating personnel for the purposes of inspection, maintenance, repair, transport, assembly, and disassembly

4-3.1.3.1.2 The crane user's responsibilities shall include the following:

(a) complying with the requirements of this Volume, manufacturer's requirements, and those regulations applicable at the worksite

(b) designating personnel to supervise crane activities

(c) ensuring that the crane is in proper operating condition prior to initial use at the worksite by

(1) verifying that the crane owner has provided documentation that the crane meets the inspection and test requirements of paras. 4-2.1.3, 4-2.1.4, and 4-2.3

(2) verifying that a frequent inspection has been performed as defined in para. 4-2.1.3

(d) verifying that the crane has the necessary lifting capacity to perform the proposed lifting operations in the planned configuration

(e) using crane operators that meet the requirements of para. 4-3.1.2 and are qualified to perform the tasks that will be required with the crane to which they are assigned to operate

(f) ensuring the designated operator(s) has been notified of adjustments or repairs that have not yet been completed, prior to commencing crane operations

(g) designating personnel for inspections as required in Sections 4-2.1 and 4-2.5

(h) designating personnel for the purposes of maintenance, repair, transport, assembly, and disassembly, as applicable

(i) ensuring that all personnel involved in maintenance, repair, transport, assembly, disassembly, and inspection, as applicable, are aware of their responsibilities, assigned duties, and the associated hazards

(j) ensuring that the inspection, testing, and maintenance programs specified by the crane owner are followed

4-3.1.3.2 Responsibilities of Site Supervisor and Lift Director. In some situations, the site supervisor and lift director may be the same person.

4-3.1.3.2.1 The site supervisor's responsibilities shall include the following:

(a) ensuring that the crane meets the requirements of Chapter 4-2 prior to initial site usage.

(b) determining if additional regulations are applicable to crane operations.

(c) ensuring that a qualified person is designated as the lift director.

(d) ensuring that crane operations are coordinated with other jobsite activities that will be affected by or will affect lift operations.

(e) ensuring that the area for the crane is adequately prepared. The preparation includes, but is not limited to, the following:

(1) sufficient room to assemble and disassemble the crane, as applicable

(2) an operating area that is suitable for the crane with respect to water conditions, support capability, proximity to power lines, and obstructions to crane operation

(3) traffic control as necessary to restrict unauthorized access to the crane's working area

(f) ensuring that work involving the assembly and disassembly, as applicable, of the crane is supervised by a qualified person.

(g) ensuring that crane operators meet the requirements of para. 4-3.1.2.

(h) ensuring that conditions that may adversely affect crane operations are addressed. Such conditions include, but are not limited to, the following:

- (1) wind velocity or gusting winds
- (2) heavy rain
- (3) fog
- (4) extreme cold
- (5) artificial lighting
- (6) river traffic

(i) allowing crane operation near electric power lines only when the requirements of para. 4-3.4.2 are met.

(j) permitting special lifting operations only when equipment and procedures required by this Volume, the crane manufacturer, or a qualified person are employed. Such operations include, but are not limited to, the following:

- (1) multiple crane lifts
- (2) lifting personnel

(k) designating a person to supervise the work performed by the rigging crew.

(l) designating a person to perform crane maintenance.

4-3.1.3.2.2 The lift director's responsibilities shall include the following:

(a) being present at the jobsite during lifting operations.

(b) stopping crane operations if alerted to an unsafe condition affecting those operations.

(c) ensuring that the preparation of the area needed to support crane operations has been completed before operations commence.

(d) ensuring necessary traffic controls are in place to restrict unauthorized access to the crane's work area.

(e) ensuring that personnel involved in crane operations understand their responsibilities, assigned duties, and the associated hazards.

(f) addressing safety concerns raised by the operator or other personnel and being responsible if it is decided to overrule those concerns and crane operations are directed to continue. (In all cases, the manufacturer's criteria for safe operation and the requirements of this Volume shall be adhered to.)

(g) designating a signalperson(s) and conveying that information to the crane operator.

(h) allowing crane operation near electric power lines only when the requirements of para. 4-3.4.2 and any additional requirements determined by the site supervisor have been met.

(i) ensuring precautions are implemented when hazards associated with special lifting operations are present. Such operations include, but are not limited to, the following:

- (1) multiple crane lifts
- (2) lifting personnel

(j) ensuring that the applicable requirements of ASME B30.23 are met when lifting personnel.

(k) informing the crane operator of the weight of loads to be lifted, as well as the lifting, moving, and placing locations for these loads.

(l) obtaining the crane operator's verification that this weight does not exceed the crane's rated capacity.

(m) designating personnel to perform the crane's load rigging.

(n) ensuring that the load is properly rigged and balanced before it is lifted more than a few inches.

4-3.1.3.3 Responsibilities of Crane Operators. The operator shall be responsible for the following listed items. The operator shall not be responsible for hazards or conditions that are not under his direct control and that adversely affect the lift operations. Whenever the operator has doubt as to the safety of operations, the operator shall stop the crane's functions in a controlled manner. Lift operations shall resume only after safety concerns have been addressed or the continuation of crane operations is directed by the lift director.

4-3.1.3.3.1 The operator's responsibilities shall include the following:

(a) reviewing the requirements for the crane with the lift director before operations.

(b) knowing what types of site conditions could adversely affect the operation of the crane and consulting with the lift director concerning the possible presence of those conditions.

(c) understanding and applying the information contained in the crane manufacturer's operating manual.

(d) understanding the crane's functions and limitations, as well as its particular operating characteristics.

(e) using the crane's load/capacity chart(s) and diagrams and applying all notes and warnings related to the charts to confirm the correct crane configuration to suit the load, site, and lift conditions.

(f) refusing to operate the crane when any portion of the load or crane would enter the danger zone of energized power lines shown in Fig. 4-3.4.2-1.

(g) performing a daily inspection of the crane as specified in para. 4-2.1.2.

(h) promptly reporting the need for any adjustments or repairs to a designated person.

(i) following applicable lock-out/tag-out procedures.

(j) not operating the crane when physically or mentally unfit.

(k) ensuring that all controls are in the off or neutral position and that all personnel are in the clear before energizing the crane or starting the engine.

(l) not engaging in any practice that will divert his attention while actually operating the crane controls.

(m) testing the crane function controls that will be used and operating only if those function controls respond properly.

(n) operating the crane's functions, under normal operating conditions, in a smooth and controlled manner.

(o) knowing and following the procedures specified by the manufacturer or approved by a qualified person, for assembly, disassembly, setting up, and reeving the crane, as applicable.

(p) knowing how to travel the crane.

(q) ensuring that the load and rigging weight(s) have been provided.

(r) calculating or determining the net capacity for all configurations that will be used and verifying, using the load/capacity chart(s), that the crane has sufficient net capacity for the proposed lift.

(s) considering all factors known that might affect the crane capacity and informing the lift director of the need to make appropriate adjustments.

(t) knowing the standard and special signals as specified in Section 4-3.3 and responding to such signals from the person who is directing the lift or a designated signalperson. (When a signalperson is not required as part of the lift operation, the operator is then responsible for the movement of the crane. However, the operator shall obey a stop signal at all times, no matter who gives it.)

(u) understanding basic load rigging procedures. For responsibility of rigging the load and ensuring that the load is rigged properly, see para. 4-3.1.3.4.

(v) if power fails during operations

(1) setting all brakes and locking devices

(2) moving all clutch or other power controls to the off or neutral position

(3) landing any load suspended below the hook under brake control, if practical

(w) before leaving the crane unattended

(1) landing any load suspended below the hook.

(2) disengaging the master clutch.

(3) setting hoist brakes, swing brakes, boom brakes, and other locking devices.

(4) putting controls in the off or neutral position.

(5) stopping the engine. An exception to this may exist when crane operation is frequently interrupted during a shift, and the operator must leave the crane. Under these circumstances, the engine may remain running, and (w)(1) through (w)(4) above shall apply. The operator shall be situated where any entry to the crane can be observed.

(6) considering the recommendations of the manufacturer for securing the crane, when a local weather storm warning exists.

4-3.1.3.4 Rigger's Responsibilities. Riggers assigned to a load-handling activity shall at a minimum be responsible for the following:

(a) ensuring the weight of the load and its approximate center of gravity have been obtained, provided, or calculated

(b) selecting the proper rigging equipment, inspecting it, and complying with the applicable operating practices according to the criteria of the applicable ASME volume (e.g., B30.9, B30.10, B30.20, B30.23, B30.26)

(c) ensuring the rated load of the rigging equipment selected is sufficient for the load to be handled, based on the number of legs, hitch configuration, and effects of angles

(d) properly attaching the rigging equipment to the hook, shackle, or other load-handling device

(e) ensuring that rigging equipment is adequately protected from abrasion, cutting, or other damage during load handling activities

(f) rigging the load in a manner to ensure balance and stability during the load handling activity

(g) knowing and understanding the applicable signals for the equipment in use

(h) installing and using a tag line(s) when additional load control is required

SECTION 4-3.2: OPERATING PRACTICES

4-3.2.1 Handling the Load

(15)

(a) *Size of Load*

(1) No crane shall be loaded beyond the rated loads given in the rating chart except for test purposes as provided in paras. 4-1.1.3 and 4-2.3.2.

(2) The load to be lifted is to be within the rated load of the crane in its existing configuration.

(3) For lifts where the load weight is not accurately known, the lift director shall ascertain that the weight of the load does not exceed the crane ratings at the radius at which the load is to be lifted.

(4) When rotation-resistant ropes are used with a design factor of less than 5 as permitted under para. 4-1.4.5(b), the special provisions that follow shall apply:

(-a) A designated person shall direct each lift.

(-b) A qualified person shall ascertain that the rope is in satisfactory condition before and after each lift [see paras. 4-2.5.2(a)(2)(-a) through (a)(2)(-e)].

(-c) Operations shall be conducted in such manner and at such speeds as to minimize dynamic effects.

(-d) Each lift under these provisions shall be recorded in the crane inspection record, and such prior uses shall be considered before permitting another such lift.

(b) Operational Aids

(1) Indicating devices shall be checked daily before the crane is put in operation (see Section 4-2.2).

(2) Load indicator readings shall be used to guide crane operations within the specifications of the load rating chart, except when load weight is accurately known from another source.

(3) Luffing boom angle or radius indicator readings shall be used to guide crane operations within the specifications of the load rating chart; however, measured operating radii shall always govern over indicated boom angles or radii.

(4) When a load-limiting device, luffing boom angle, or load or radius indicator is inoperative or malfunctioning, the crane may be kept in-service while awaiting repair, provided all of the following conditions are adhered to. No operations shall be conducted if more than one of the indicating or limiting devices are not functioning.

(-a) All crane operations are conducted under the direct supervision of a qualified person other than signalperson.

(-b) Radio communications between the qualified person, signalperson(s), and crane operator are established.

(-c) Each individual lift and the first of a series of identical repetitious lifts are specifically approved by the qualified person before the lift is made, with respect to load weight, operating radii, lift heights, and crane motions.

(5) When the wind velocity-indicating device is nonfunctioning, crane operations may continue if another crane on the site is equipped with a functioning wind velocity indicator or if a qualified person determines that ambient wind velocity is within permitted limits.

(6) When drum rotation indicators are not functioning, the crane may be kept in-service while awaiting repair.

(c) Attaching the Load

(1) The hoist rope shall not be wrapped around the load.

(2) The load shall be attached to the hook by means of slings or other devices of adequate capacity.

(d) Holding the Load

(1) The operator shall not leave the controls while the load is suspended.

(2) No person should be permitted to stand or pass under a suspended load.

(3) If the load must remain suspended for any considerable length of time, the operator shall keep the drum from rotating in the lowering direction by activating the drum-holding device, if a separate nonautomatic device has been provided.

(4) As an exception to (d)(1) above, where a load is to be held suspended for a period of time exceeding

normal lifting operations, the operator may leave the controls, provided that prior to that time, the appointed individual and operator shall have established the requirements for restraining the load, swing, and travel functions and provided barricades or whatever other precautions may be necessary.

(e) Moving the Load

(1) The lift director shall see that

(-a) proper slings or other lifting attachments are being used

(-b) the load is well secured and balanced in the sling or lifting device before it is lifted more than a few inches

(-c) the lift and swing path is clear of obstructions

(2) Before starting to lift, the following conditions should be noted:

(-a) Hoist rope shall not be kinked.

(-b) Multiple part lines shall not be twisted around each other.

(-c) The hook shall be brought over the load in such a manner as to minimize swinging.

(-d) If there is a slack rope condition, it shall be determined that the rope is seated on the drum and in the sheaves, as the slack is removed.

(-e) The effect of wind on the load and on the crane should be noted.

(-f) The load is free to be lifted; it is not caught on, nor attached to, other objects.

(3) During lifting, care shall be taken that

(-a) there is no sudden acceleration or deceleration of the moving load

(-b) the load does not contact any obstructions

(4) Side loading of booms shall be limited to freely suspended loads. Cranes should not be used for dragging loads.

(5) The operator should avoid carrying loads over people.

(6) The operator shall test the brakes each time a load approaching the rated load is handled by lifting it a few inches and applying the brakes.

(7) The load shall not be lowered below the point where less than two full wraps of rope remain on the drum.

(8) When swinging the boom or traveling the crane, sudden starts and stops shall be avoided. Swing and travel speeds shall be such that the load does not swing out beyond the radius at which it can be controlled. A tag or restraint line shall be used when swinging of the load is hazardous.

(9) Consideration should be given to the effects of wind on loads with a large sail area.

4-3.2.2 Personnel Lifting**(15)**

This Volume recognizes that portal and pedestal cranes are designed and intended for handling materials and not personnel. Personnel are only permitted to ride

in a personnel platform supported by the crane load line attachment or boom-mounted platform when used in accordance with the requirements of ASME B30.23 and the crane manufacturer's instructions. The crane shall not be used for other purposes while handling personnel. (Refer to ASME B30.23.)

SECTION 4-3.3: SIGNALS

(15) 4-3.3.1 General

(a) Communication between the crane operator and signalperson shall be maintained continuously during all crane movements. If at any time communication is disrupted, the operator shall stop all crane movements until communication is restored and a proper signal is given and understood.

(b) If the operator has any concerns regarding the requested movement of the crane or needs to communicate with the signalperson, the operator shall stop all crane movement. Crane movement shall not resume until the operator and signalperson agree the issue at hand has been resolved.

(c) If it is desired to give instructions to the operator, other than those provided by the established signal system, the crane movements shall be stopped.

(15) 4-3.3.2 Standard Signals

Standard signals to the operator shall be in accordance with the standards prescribed in para. 4-3.3.4 or 4-3.3.5. Signals shall be discernible or audible at all times. No crane motion shall be made unless signals are clearly understood.

(15) 4-3.3.3 Signalperson Qualifications

Prior to signaling crane operations, all signalpersons shall be tested by a designated person and demonstrate their qualifications in the following areas:

(a) basic understanding of crane operation and limitations

(b) standard hand signals described in para. 4-3.3.4 whenever hand signals are used

(c) standard voice signals described in para. 4-3.3.5 whenever voice signals are used

(15) 4-3.3.4 Standard Hand Signals

Hand signals shall be in accordance with Fig. 4-3.3.4-1 and shall be posted at the worksite.

(15) 4-3.3.5 Standard Voice Signals

Prior to beginning lifting operations using voice signals, the signals shall be discussed and agreed upon by the person directing lifting operations, the crane operator, and the appointed signalperson.

(a) Telephones, radios, or equivalent, if used, shall be tested before lifting operations begin. If the system is battery powered, extra batteries should be available at the jobsite.

(b) Prior to commencing a lift, the operator and signalperson shall contact and identify each other.

(c) All directions given to the crane operator by the signalperson shall be given from the operator's direction perspective (e.g., swing right).

(d) Each series of voice signals shall contain three elements stated in the following order:

- (1) function and direction
- (2) distance and/or speed
- (3) function stop

NOTE: The following are some examples of signals:

(a) swing right 50 ft, 25 ft, 15 ft, 10 ft, 5 ft, 2 ft, swing stop

(b) load down 100 ft, 50 ft, 40 ft, 30 ft, . . . 2 ft, load stop

(c) load up slow, slow, slow, load stop

(e) For lifting operations using voice signals, the person directing lifting operations shall consider the complexity of the lift, the capabilities of the particular crane, the experience and skill of the operator and signalperson, and the ability to communicate the necessary signals before permitting multiple simultaneous crane function signals.

4-3.3.6 Special Signals

(15)

For operations not covered by para. 4-3.3.4, 4-3.3.5, or 4-3.3.7, additions to or modifications of the standard signals may be required. In such cases, the required special signals shall be agreed upon in advance by the lift director, operator, and signalperson. These special signals should not be in conflict with the standard signals.

4-3.3.7 Audible Travel Signals

(15)

When moving the vehicle, the following signals shall be used:

- (a) STOP: one short audible signal
- (b) GO AHEAD: two short audible signals
- (c) BACK UP: three short audible signals

4-3.3.8 Audible Emergency Signal

(15)

Emergency signals can be given by anyone. The signal used shall be agreed upon for each jobsite location, and it shall meet the requirements of para. 4-3.3.6 (e.g., multiple short audible signals or a continuous audible signal).

SECTION 4-3.4: MISCELLANEOUS

4-3.4.1 Rail Clamps

Rail clamps, if used, should have slack between the point of attachment to the rail and the end fastened to the crane. Rail clamps shall not be used as a means of restraining tipping of a crane.

4-3.4.2 Operating Near Electric Power Lines

(a) Cranes shall be operated so that no part of the crane or load enters into the Danger Zone shown in Fig. 4-3.4.2-1.

Fig. 4-3.3.4-1 Standard Hand Signals for Controlling Portal and Pedestal Cranes



 <p>HOIST. With forearm vertical, forefinger pointing up, move hand in small horizontal circle.</p>	 <p>LOWER. With arm extended downward, forefinger pointing down, move hand in small horizontal circle.</p>	 <p>USE MAIN HOIST. Tap fist on head; then use regular signals.</p>
 <p>USE WHIPLINE (Auxiliary Hoist). Tap elbow with one hand; then use regular signals.</p>	 <p>RAISE BOOM. Arm extended, fingers closed, thumb pointing upward.</p>	 <p>LOWER BOOM. Arm extended fingers closed, thumb pointing downward.</p>
 <p>MOVE SLOWLY. Use one hand to give any motion signal and place other hand motionless in front of hand giving the motion signal. (Hoist slowly shown as example.)</p>	 <p>RAISE THE BOOM AND LOWER THE LOAD. With arm extended, thumb pointing up, flex fingers in and out as long as load movement is desired.</p>	 <p>LOWER THE BOOM AND RAISE THE LOAD. With arm extended, thumb pointing down, flex fingers in and out as long as load movement is desired.</p>

Fig. 4-3.3.4-1 Standard Hand Signals for Controlling Portal and Pedestal Cranes (Cont'd)



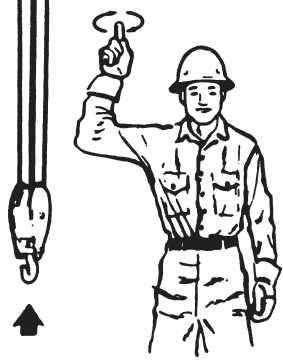
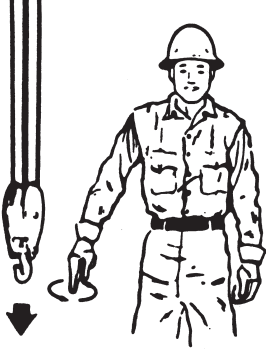
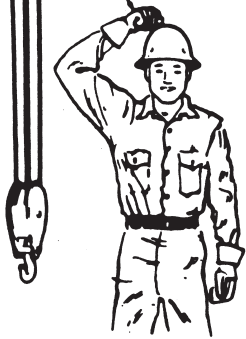

 <p>SWING. Arm extended, point with finger in direction of swing of boom.</p>	 <p>STOP. Arm extended, palm down, move arm back and forth.</p>	 <p>EMERGENCY STOP. Both arms extended, palms down, move arms back and forth.</p>
 <p>EXTEND BOOM (Telescoping Boom). One Hand Signal. One fist in front of chest with thumb tapping chest.</p>	 <p>DOG EVERYTHING. Clasp hands in front of body.</p>	 <p>RETRACT BOOM (Telescoping Boom). One Hand Signal. One fist in front of chest, thumb pointing outward and heel of fist tapping chest.</p>

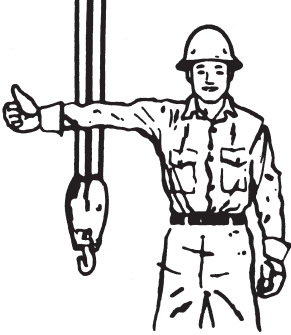
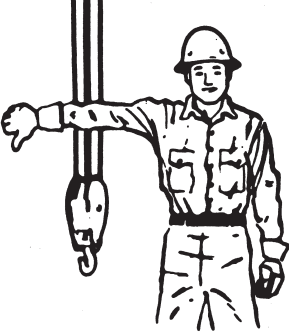
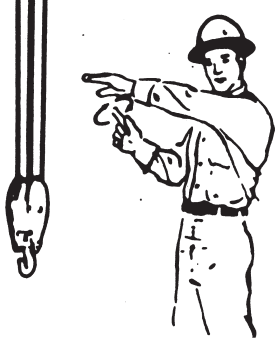
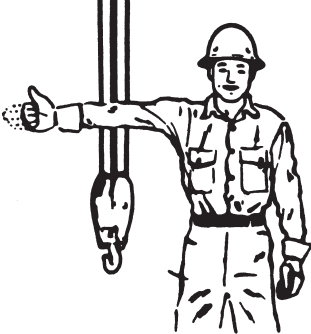
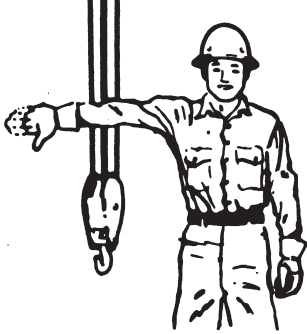
Fig. 4-3.4.2-1 Danger Zone for Cranes and Lifted Loads Operating Near Electrical Transmission Lines

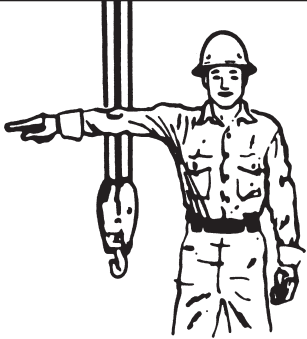
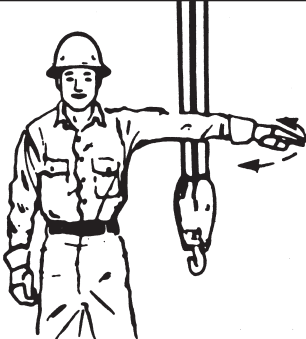
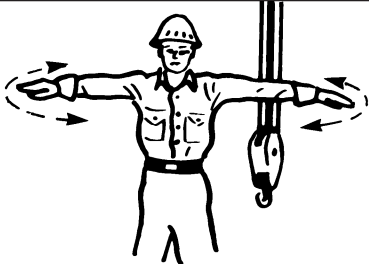

NOTE:

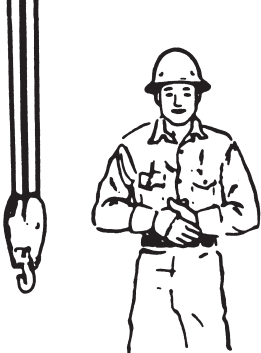
(1) For minimum radial distance of danger zone, see para. 4-3.4.2.

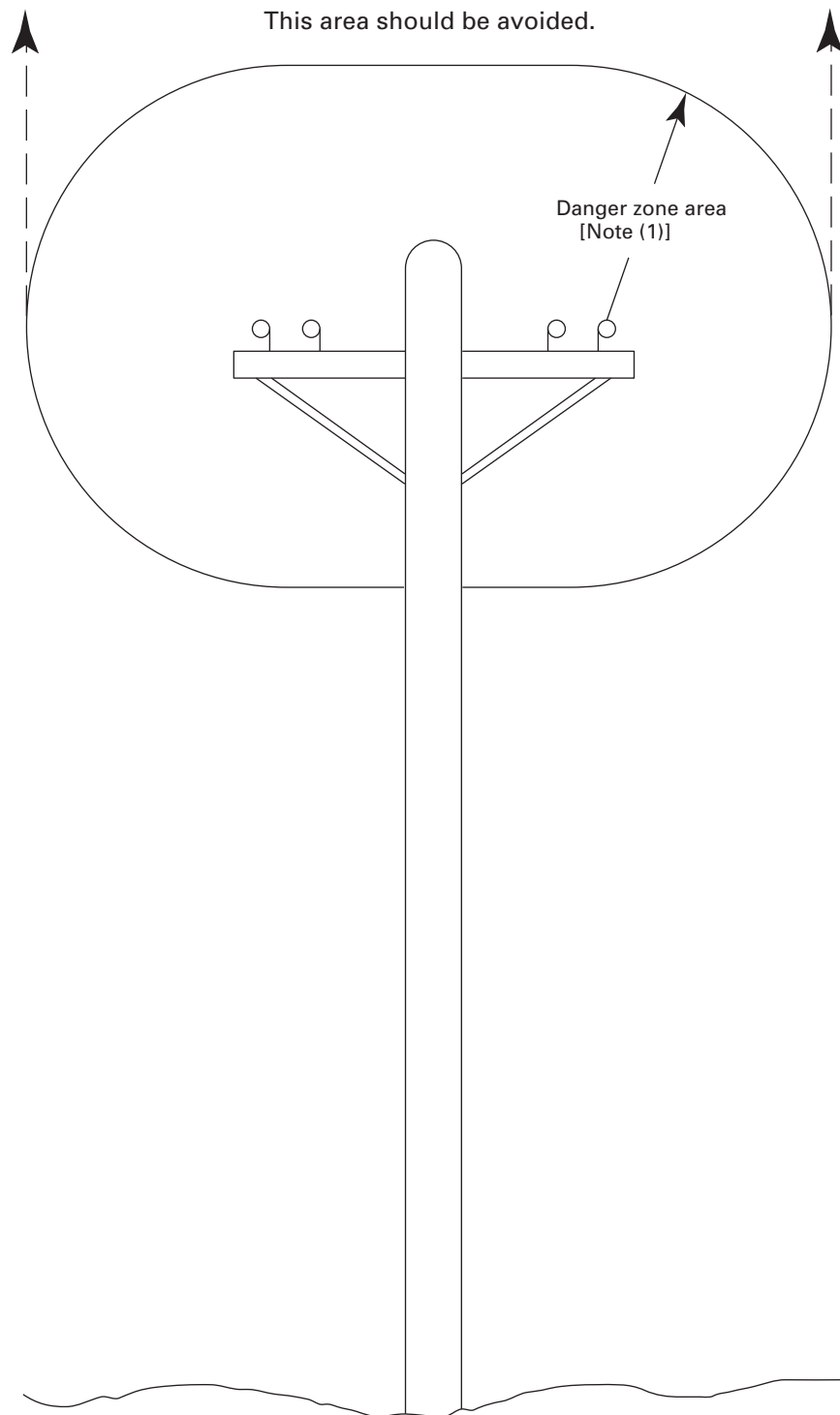
Table 4-3.4.2-1 Required Clearance for Normal Voltage in Operation Near High Voltage Power Lines

Normal Voltage, kV (Phase to Phase)	Minimum Required Clearance	
	ft	m
Operation near high voltage power lines to 50	10	3.06
Over 50 to 200	15	4.6
Over 200 to 350	20	6.1
Over 350 to 500	25	7.62
Over 500 to 750	35	10.67
Over 750 to 1 000	45	13.72

(1) *Exceptions*

(-a) The Danger Zone may be entered if the electrical distribution and transmission lines have been de-energized and visibly grounded at the point of work or

(-b) The Danger Zone may be entered if insulating barriers (not a part of nor attachment to the crane) have been erected to prevent physical contact with the lines.

(2) For lines rated 50 KV or below, minimum clearance between the lines and any part of the crane or load (including handling appendages) shall be 10 ft (3 m). For higher voltages, see Table 4-3.4.2-1.

(3) Caution shall be exercised when working near overhead lines, because they can move horizontally or vertically due to wind, moving the Danger Zone to new positions.

(4) A qualified signalperson shall be assigned to observe the clearance when the crane moves to within a boom's length of the Table 4-3.4.2-1 limits. The operator is not in the best position to judge distance between the power line and the crane or its protuberances.

(b) If cage-type boom guards, insulating links, or proximity warning devices are used on cranes, such devices shall not be a substitute for the requirements of (a) above, even if such devices are required by law or regulation. In view of the complex, invisible, and lethal nature of the electrical hazard involved, and to lessen the potential of false security, limitations of such devices, if used, shall be understood by operating personnel and tested in the manner and in intervals prescribed by the

manufacturer of the device. Compliance with (a) above is the recommended practice of this Standard in determining permissible proximity of the crane and its protuberances, including load and load lines to electrical power lines.

(c) Before the commencement of operations near electrical lines. The person responsible for the job shall notify the owners of the lines or their authorized representatives, providing them with all pertinent information and requesting their cooperation.

(d) Any overhead wire shall be considered to be an energized line unless and until the person owning such line or the electrical utility authorities verify that it is not an energized line.

(e) Exceptions to this procedure, if approved by the owner of the electrical lines, may be granted by the administrative or regulatory authority if the alternate procedure provides protection and is set forth in writing.

(f) When a crane is installed in proximity to power lines, durable signs shall be installed at the operator's station and on the base of the crane, warning that electrocution or serious bodily injury may occur unless a minimum clearance of 10 ft (3 m) is maintained between the crane or the load being handled and energized power lines. Greater clearances are required because of higher voltage, as stated in (a)(2) above. These signs shall be revised when local jurisdiction requires greater clearances.

4-3.4.3 Cabs

(a) Necessary clothing and personal belongings shall be stored in such a manner as to not interfere with access or operation.

(b) Tools, oilcans, waste, and other necessary articles shall be stored in the toolbox and shall not be permitted to lay loose in or about the cab.

4-3.4.4 Refueling

(a) When refueling with gasoline using a portable container, it shall be a safety-type can equipped with automatic closing cap and flame arrester.

(b) Machines shall not be refueled with the engine running.

(c) Smoking or open flames shall be prohibited in the refueling area.

ASME B30.4-2015

ISBN 978-0-7918-7013-6



9 780791 870136



J10315